

The Samsung logo is positioned in the upper left corner of the page. It consists of the word "SAMSUNG" in a bold, white, sans-serif font, centered within a dark, horizontally-oriented oval shape. The background of the entire page is a grayscale image featuring a complex network of circuit traces and a large, multi-lobed antenna structure, suggesting a high-tech or surveillance theme.

SAMSUNG

8 Channel DVR

SHR-4081N/P User's Manual

English

Safety Regulations

Please be sure to keep the following in mind for the right use of the product to pre-vent proprietary risk or damage.

- **Do not use multiple plugs at once.**
 - This may cause abnormal heat generation or fire
- **Do not put a vase, flowerpot, cup, cosmetics, medicine, or vessel with water around you.**
 - This may cause fire.
- **Do not bend the power cord forcibly nor put a heavy material on it.**
 - This may cause fire.
- **Do not touch the power plug with wet hands.**
 - This may cause electric shock.
- **Insert the power plug firmly enough not to shake.**
 - This imperfect connection may cause fire.
- **Keep the product off humidity, dust, or soot.**
 - This may cause fire or electric shock.
- **Do not put metals(coin, hair pin, metal piece, etc.) or inflammable materials(match, paper, etc.) in the ventilation hole.**
 - This may cause fire.
- **Keep the surrounding temperature between 0°C to 40°C and keep the product off humidity.**
 - This may cause breakdown.
- **Secure sufficient ventilation.**
 - This may cause abnormal operation due to high temperature.
- **Keep the product off direct ray of light or heat from the heating device**
 - This may cause fire.
- **Do not disassemble, repair, or remodel the product.**
 - This may cause fire, electric shock, or injury due to abnormal operation.
- **Do not pull out the power cord.**
 - This may destroy the power cord, eventually, cause fire or electric shock.
- **Plug out in the event of thunder or lightning.**
 - This may cause fire.
- **Keep your children off the battery after you take it out of the product. They tend to swallow it unconsciously.**
 - If your children swallow it, please see the doctor immediately.
- **Install the product at a safe place or attach the product to the wall or ceiling with a stand firmly enough not to fall to the ground.**
 - This may injure people.



Before we start

This User's Manual describes the basic usage of SHR-4081N/P. This Manual contains all the matters necessary for using SHR-4081N/P such as brief instruction, part name, function, connecting other equipment, and menu setup of SHR-4081N/P.

- SEC retains the copyright on this User's Manual.
- This User's Manual cannot be copied without SEC's prior written approval.
- We are not liable for any or all losses to the product incurred by your use of non-standard product or violation of User's Manual.
- If you want to open the system case to touch the inside, please consult with an expert who works for the shop where you bought the product.
- You may download open source codes from the following website.
(See CCTV Part of <http://www.samsung.com>)

WARNING

[Battery]

If the batteries for the SHR-4081N/P products are replaced incorrectly, there will be explosion risks. Please use the same batteries used in the SHR-4081N/P products. The battery specification is as follows.

- Normal Voltage : 3V
- Normal Capacity : 220mAh
- Continuous Standard Load : 0.2mA
- Operating Temperature : -30 ~ +60°C

[System Shutdown]

- Power-off without terminating the system in the System Shutdown menu may incur improper motion like data loss and disk failure. Power-off shall be done in the System Shutdown menu. Abruptly disconnecting the power supply during a normal operation of this product may damage the HDD and the product. The safest way to disconnect the power is to end the power by running the "Power Exit" from the system menu. To prevent the product from any damage caused by a sudden power shortage and so forth, install a separate UPS system for a stable operation. (Please contact your UPS vendor for questions related to UPS.)

[Operation Temperature]

The guaranteed operation temperature of the device is from 0°C (32°F) to 45°C (113°F). The device may not operate when it is used immediately after having been stored below the guaranteed temperature for a long period of time. When the device has been stored under a low temperature for a long time, please store it under an ambient temperature for a certain period of time before operating it. Especially since the guaranteed temperature for the HDD installed inside is from 5°C(41°F) to 55°C(131°F), it might not operate under a low temperature.

Standards Approvals



Note : This equipment has been tested and found to comply with the limits for a Class A digital device, pursuant to part 15 of the FCC Rules. These limits are designed to provide reasonable protection against harmful interference when the equipment is operated in a commercial environment. This equipment generates, uses, and can radiate radio frequency energy and, if not installed and used in accordance with the instruction manual, may cause harmful interference to radio communications. Operation of this equipment in a residential area is likely to cause harmful interference in which case the user will be required to correct the interference at his own expense.

Contents

ii	Safety Regulations	5	Chapter 5 Menu Setup
iii	Before we start	5-1	Before Use
	Standards Approvals	5-2	1. System
1	Chapter 1 Overview	5-12	2. Camera
1-1	1. Introduction	5-16	3. Monitoring
1-2	2. Features	5-18	4. Record Mode
1-3	3. Part Names and Functions	5-19	5. Event Record Mode
2	Chapter 2 Installation	5-24	6. Record Schedule
2-1	1. Installation Environment Setup	5-26	7. Backup
2-3	2. Checking Product & Accessories	5-28	8. Network
2-4	3. Additional HDD Installation	5-32	9. Network Setup
3	Chapter 3 Connecting with Other Equipment	6	Chapter 6 PTZ Device Control
3-1	1. Connecting Video, Audio, & Monitor	6-1	1. PTZ device Control Mode
3-2	2. Connecting Network	6-3	2. Basic Operation of PAN, TILT, & ZOOM
3-3	3. Connecting IEEE1394 Device	6-4	3. PRESET Setup
3-5	4. Connecting USB Device	6-6	4. Camera Menu Setup
3-6	5. Connecting Alarm Input/Output	6-7	5. Preset View
3-8	6. Connecting RS-485 Device	6-8	6. Other Views
4	Chapter 4 Live	7	Chapter 7 Recording
4-1	1. System Motion	7-1	1. PANIC (Emergency Recording)
4-2	2. Live Screen Mode	7-2	2. REC (Normal Recording)
4-5	3. Live Channel Selection and Audio On/Off Setup	7-3	3. Record Schedule
4-6	4. Freeze and Zoom	7-4	4. Event Recording
4-7	5. Event Monitoring	8	Chapter 8 Search & Play
4-8	6. Spot-out Monitoring	8-1	Before Use
		8-2	1. Calendar Search
		8-3	2. Event Search
		8-4	3. Date/Time Search
		8-5	4. Go to First Search
		8-6	5. Go to Last Search
		8-7	6. Play

9	Chapter 9 Backup and Backup Search
9-1	1. Backup
9-4	2. Backup Search
10	Chapter 10 Smart Viewer
10-1	1. Introduction
10-2	2. Feature
10-3	3. PC Specification(Recommendation)
10-4	4. Smart Viewer Installation
10-7	5. Smart Viewer Program Execution
10-8	6. Smart Viewer Initial Screen
10-9	7. Monitoring Mode
10-23	8. Search Mode
10-30	9. SETUP MODE
11	Chapter 11 Backup Viewer
11-1	1. Introduction
11-2	2. Features
11-3	3. PC Specification(Recommendation)
11-4	4. Backup Viewer Installation
11-8	5. Executing Backup Viewer Program
11-9	6. Initial Screen of Backup Viewer
11-10	7. Using Backup Viewer
12	Appendix
12-1	1. Product Specification
12-4	2. HDD Specifications
12-5	3. Outline Drawing
12-6	4. Factory Default
12-8	5. SHR-4081N/P Smart Viewer Play Frame Specification
12-9	6. Troubleshooting(FAQ)



Chapter 1

Overview

1 Introduction

The Digital Video Recorder(DVR) compresses the camera input data from 8 channels into a MPEG4 video file and the voice input data into a G.726 audio file respectively to record them in the Hard Disk or retrieve them from the Hard Disk simultaneously.

In addition, it transmits the video or audio file out through a network on real time basis so that you can monitor either file remotely by your PC.

2 Features

- 8 CH Composite Input Connectors
- NTSC/PAL Video Source Compatible
- Able to record the CIF size (NTSC : 352 x 240 / PAL : 352 x 288) video image at the speed of 240ips(NTSC) / 300ips(PAL)
- 8 CH Loop Through Video Connectors
- Hard Disk Overwrite Mode
- Large quantity HDD backup function by using IEEE1394 and USB2.0, USB2.0 Memory, Backup function by using an external CD/DVD writer.
- Able to record, play, and transmit both audio and video files to Windows Network Viewer(Smart Viewer) simultaneously
- Able to record and replay 8 channels of Audio
- Variable Search Mode (Time/Date, Event, Camera)
- Variable Recording Mode (Time Lapse, Event, Schedule, Emergency)
- Extended Hard Disk Connection (IEEE1394, USB2.0)
- Alarm Interface (Input : 8, Output : 4, Reset : 1)
- Remote Monitoring by Windows Network Viewer(Smart Viewer)

3 Part Names and Functions

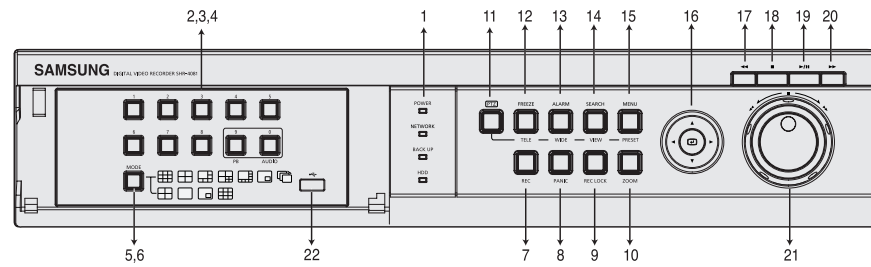

No	Name	Function	
1	Power LED	Displays power on/off condition.	
	Network LED	Displays both network connection and data transmission conditions.	
	Backup LED	Displays Backup Mode.	
	HDD Access LED	Indicates Normal Access to HDD. Upon Access to HDD, LED repeats on and off.	
2	Channel Button	Selects Single Channel in the Display Mode. Used for Number Input Button in the Number Input Mode.	
3	Audio Setup Button	Audio On/Off setup during play mode.	
4	Split Screen Selection Button	Display Mode	9 Displays Split Screen.
			4 Displays Split Screen.
			6 Displays Split Screen.
			7 Displays Split Screen.
			8 Displays Split Screen.
			Displays PIP(Picture In Picture) Screen.
			Screen change Mode : Enters Single Channel Screen by the time set in MENU.
5	Mode Selection Button	Search	4 Displays Split Screen.
			Displays the selected channel in Full Screen.
			Displays both LIVE Channel and Play Channel in PIP Screen simultaneously.
			9 Displays Split Screen.
6	REC Button	Recording starts as set in the Normal Record Mode while LED is on.	

No	Name	Function
7	PANIC Button	Video/Audio, set to the system, is recorded to 15 ips(NTSC)/ 12.5 ips(PAL). The image quality of video recording is very high and its size is CIF.
8	REC LOCK Button	Locks the REC key motion.
9	ZOOM Button	Sets up Digital Zoom(x2).
10	PTZ Button	Performs the TELE, WIDE, PRESET, and VIEW function by pressing the PTZ button.
11	FREEZE(TELE) Button	Performs the FREEZE function in the DISPLAY Mode. Performs the TELE function by pressing the PTZ.
12	ALARM(WIDE) Button	Cancels the preset ALARM function to set up a new ALARM function. Performs the WIDE function by pressing the PTZ
13	SEARCH (VIEW) Button	Indicates the Search method. Performs the VIEW setup function by pressing the PTZ.
14	MENU(PRESET) Button	Displays the system setup menu or enters an upper menu. Performs the PRESET setup function by pressing the PTZ.
15		Changes or edits the left setup value for the detailed menu item setup.
		Moves the cursor up in a menu or increases the setup value for the detailed menu item setup.
		Changes or edits the right setup value for the detailed menu item setup.
		Moves the cursor down in a menu or decreases the setup value for the detailed menu item setup.
		Acts as the Enter key for the menu setup.
16	Fast Reverse	Views the fast rewinding search screen.
17	STOP	Stops file searching.
18	PLAY/PAUSE	Toggles during playback to activate PLAY/PAUSE or PLAY.
19	Fast Forward	Views the fast forwarding search screen.
20	Jog/ Shuttle	Jog : Used for the Forward/Reverse Frame search. Shuttle : Performs the Play/Reverse Play /FF/REW function.
21	USB Port	A port to connect the USB type device.

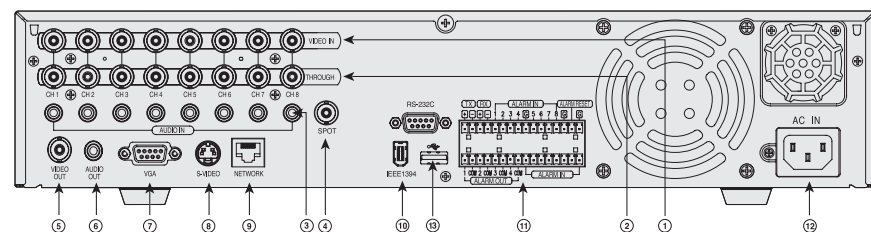

Caution

Do not play DVR on the carpet or other soft material to prevent clogging of the air ventilator.

To play DVR on the cabinet or rack, be sure to check the ventilation condition.

No	Name	Function
①	VIDEO IN	Composite Video Signal Input Port (BNC Style Connector)
②	THROUGH	You may use THROUGH port to transmit a video signal to the other video equipment.
③	AUDIO IN	Audio Signal Input Port (RCA Jack)
④	SPOT	SPOT Out Output Port (BNC Style Connector)
⑤	VIDEO OUT	Composite Video Signal Output Port (BNC Style Connector)
⑥	AUDIO OUT	Audio Signal Output Port (RCA Jack)
⑦	VGA	VGA Video Signal Output Port
⑧	S-VIDEO	S-VIDEO Video Signal Output Port
⑨	NETWORK	Network Connection Port
⑩	IEEE1394	IEEE1394 Type Device Connection Port
⑪	ALARM	- ALARM IN 1~8 : Alarm Input Port - ALARM RESET IN : Alarm Reset Port - ALARM OUT1~4 : Alarm Output Port - TX+, TX-, RX+, RX- : RS-485 Communication Port
⑫	AC-IN	Supports the AC110-220V(NTSC) power socket.
⑬	USB	A port to connect the USB type device.



Chapter 2

Installation

1 Installation Environment Setup

Do not place DVR on the carpet or other soft material to prevent clogging of the air ventilator. To place DVR on the cabinet or rack, be sure to check the ventilation condition.

You shall pay attention to the following before you use the product.

1. Do not use it outdoor.
2. Do not let water or liquid in the connection part or the product itself.
3. Do not impose excessive shock or force.
4. Do not pull out the power plug unreasonably.
5. Do not disassemble the product on your own.
6. Do not exceed the rated input or output range.
7. Use certified power cord only.
8. Match a product with an input ground with a power cord with a ground.

Samsung Digital Video Recorder (hereafter "DVR") is a high-tech security equipment that contains a high-capacity HDD and top-notch circuits. High temperature inside or outside of the product may cause reduced life and deteriorated performance (see graph 1 below), leading to a malfunction. So please follow the instructions below to proceed with the installation.

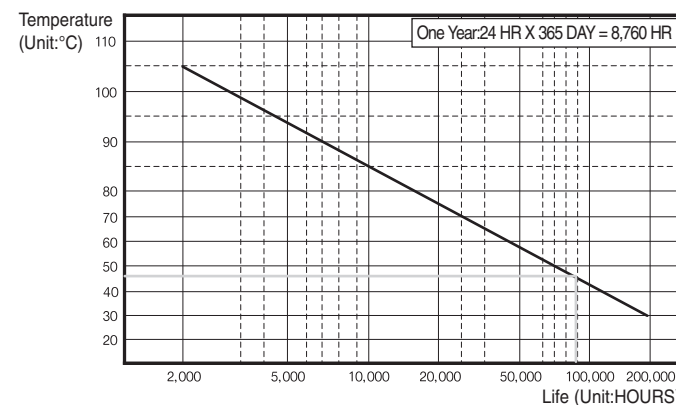

<Graph 1 : Correlation between temperature and product life>

<Instructions for the rack mounting of Samsung DVR>

1. The rack on which the DVR is mounted should not be sealed off.
2. And it also can allow air circulation through the vent.
3. As in the figure to the right, we recommend the product should be stacked up with other DVRs or rack-mounting devices at a certain space or you install a vent system to accommodate airflow.
4. For forming a natural convection, the air intake hole should be positioned at the bottom and the emission at the top.
5. We recommend you install each of the air intake and emission holes with a fan motor for sufficient airflow.
(The air intake fan should be equipped with a filter to block dust and other impurities from inflow.)
6. The temperature inside the rack and around the DVR should stay between +5°C and +45°C.

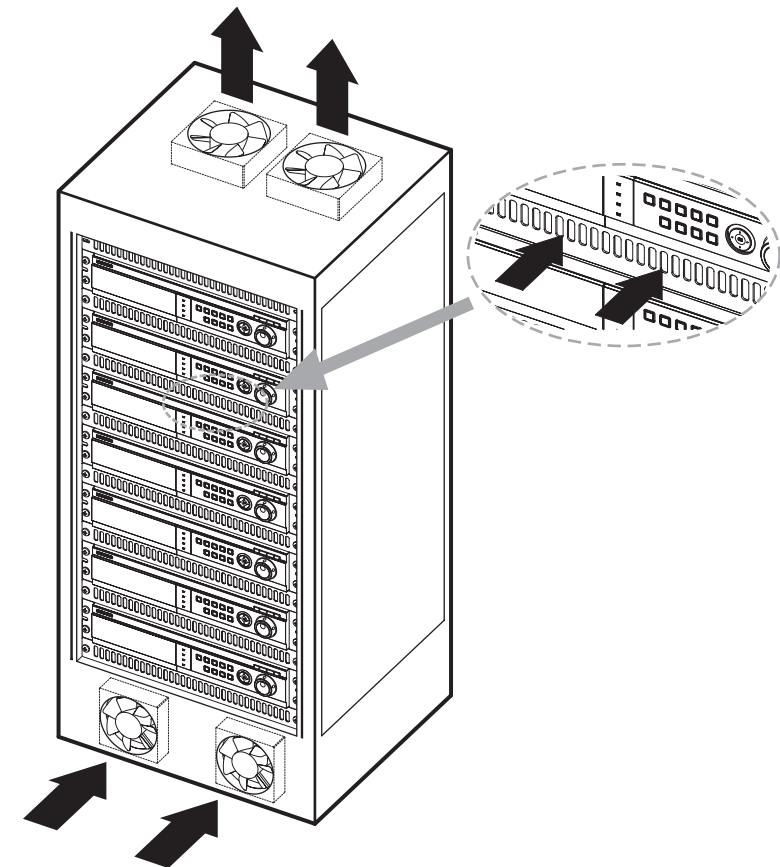

2 Checking Product & Accessories

Upon delivery of a product, you shall unwrap the product and put it on the even floor or where you want to use it. Then you shall check if the following items are in it.

- Main Body
- User's Manual
- One Power Cord
- Two Brackets
 - Brackets are used to attach the product to the rack.
- Smart Viewer Software CD (Incl. PDF Manual)
- 12 Screw Specials
 - Please keep screw specials well to be used for HDD addition.
- 2 EA of RS-485/Alarm Terminal Block

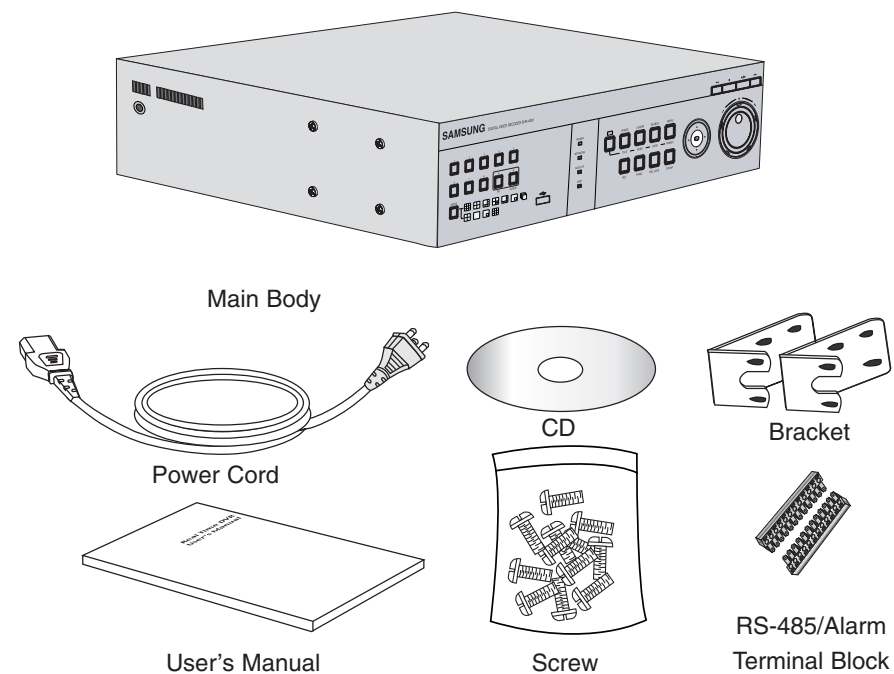

3 Additional HDD Installation

You may add up to 3 more HDDs to the product.

However, since the product contains many parts which may incur electric shock, accident, or product breakdown and improper installation or setup may disturb HDD recognition or normal product operation, you shall consult with an expert of the agency where you bought the product.

[Caution for HDD Addition]

- Do not let the cable stuck improperly nor uncoated. (This may cause breakdown or fire.)
- Be careful not to cut yourself by sharp edges of the product.
- Be careful not to miss the disassembled screws or parts. Imperfect assembly due to short of screws or parts may cause breakdown or malfunctioning.

[HDD Addition Procedure]

1. Loosen screws on both sides(5 points) and back(1 point) to detach the product cover.

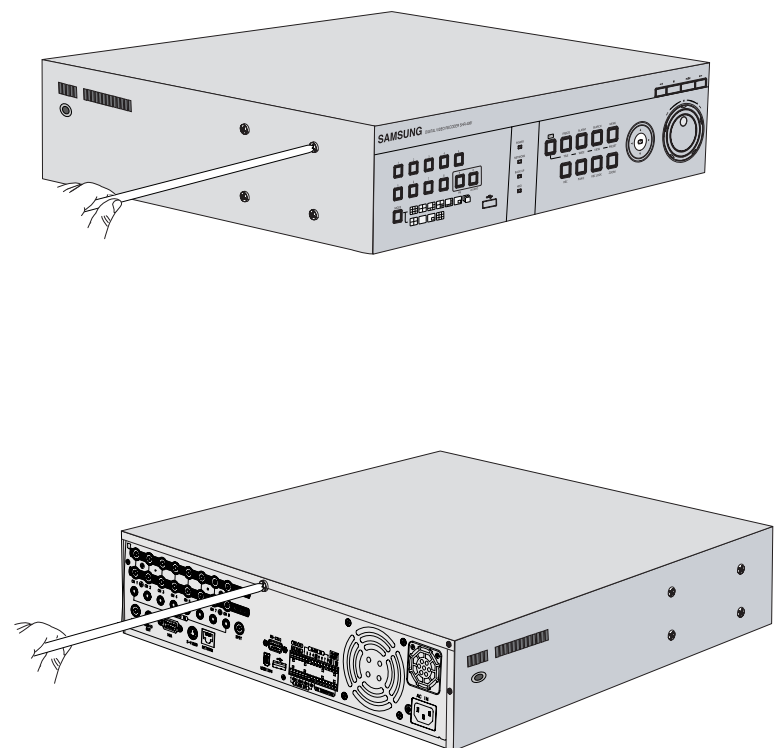

2. Detach the cover from the product. (Pull out the cover slightly and lift from the back side to detach.)

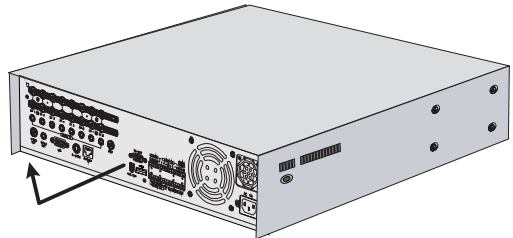

3. A bracket is fixed to each side of HDD. Please loosen the screw of the bracket to which you want to fix HDD.

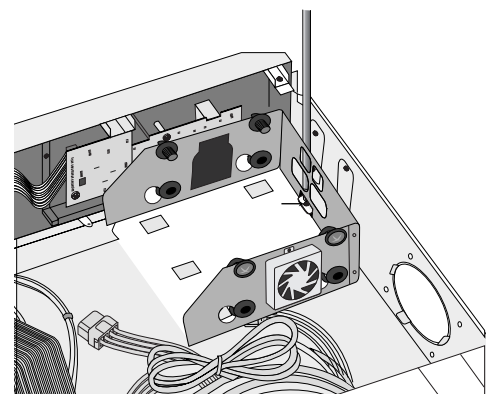
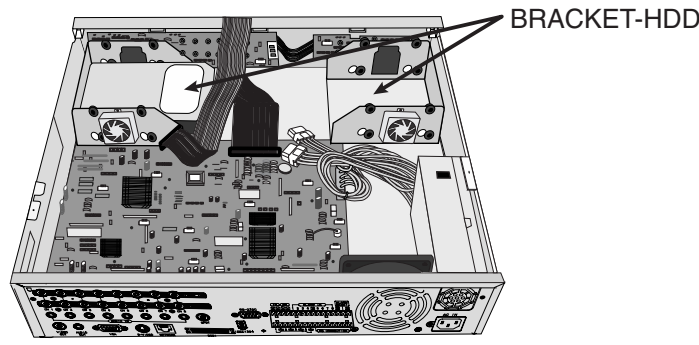

4. Pull BRACKET-HDD to the product center to detach the fixed part at the bottom to detach BRACKET-HDD from the product.

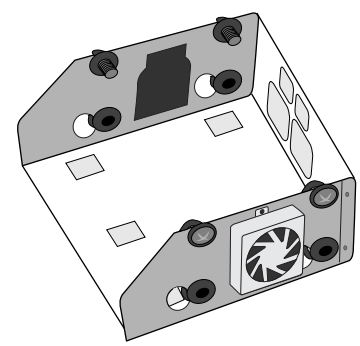
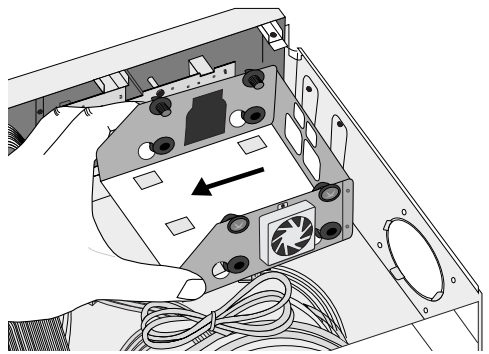

5. Tighten 4 SCREW-SPECIALs(BWH,6-32UNC,L10.5), supplied as an accessory to fix HDD to BRACKET-HDD. (Screw tighten force shall be strong enough to resist vibration.)

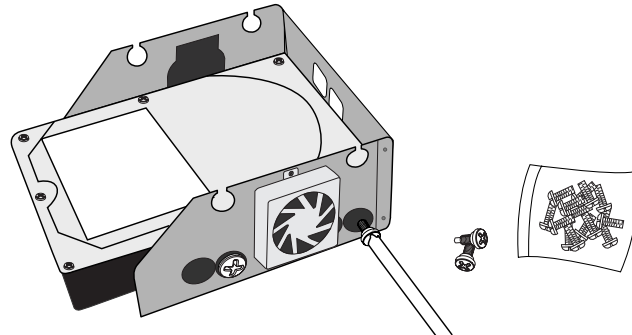

6. Restore HDD installed BRACKET-HDD.

(Assembly shall be done in the reverse procedure of disassembly as follows. Align the 5 fixing points at the bottom with the BRACKET-HDD fixing holes respectively and push BRACKET-HDD out of the product to align the screw fixing holes. Then, tighten the screws firmly.)

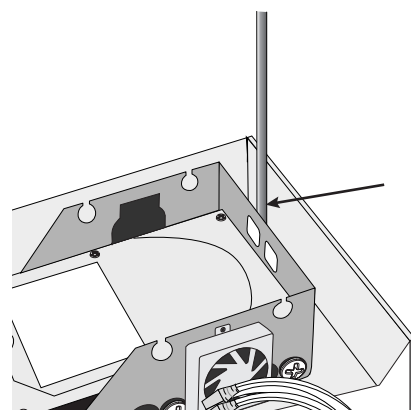

7. Check if BRACKET-HDD has been fixed to the product and connect both the power supply cable and the signal transmission cable (IDE CABLE) to the HDD.

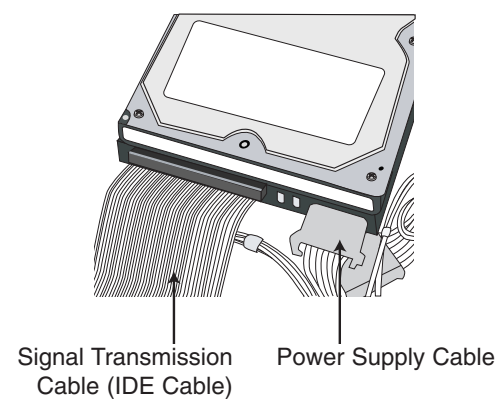

8. Check the connector, wiring, and cable fixing condition inside the product and close the cover.

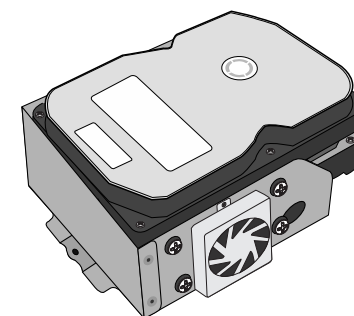
9. Tighten cover-fixing screws. (5 points on both sides and 1 point in the back side)
* You can apply 2 HDDs to each BRACKET-HDD as shown in the figure.

! **Attention**

*For HDD addition, please select the same HDD with the existing HDD fixed to the product as far as possible. This product can accept 4 more HDDs, 2 at Primary Slot and 2 at Secondary Slot respectively. Both HDDs attached to Primary Slot and Secondary Slot shall be set to Master and Slave respectively. Refer to User's Manual for Master or Slave Jumper Setting.
In the event of only one HDD installation, it shall be inserted into the Primary slot.*

Note

Refer to Appendix 2 to see which HDD specifications are supplied.

Attention

- ① Regarding the sub fan, you need additional brackets and sub fans as follows.
The sub fan is shaped like this when viewed from the front and back. Please pay attention to the fan direction to let wind go through the fan.

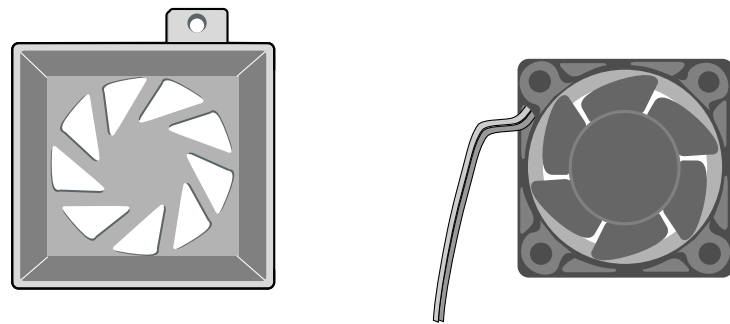

- ② Fix the fan as follows.

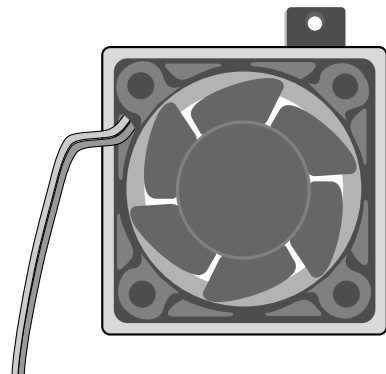

- ③ Please install the fan to be seen from the front view of the set.

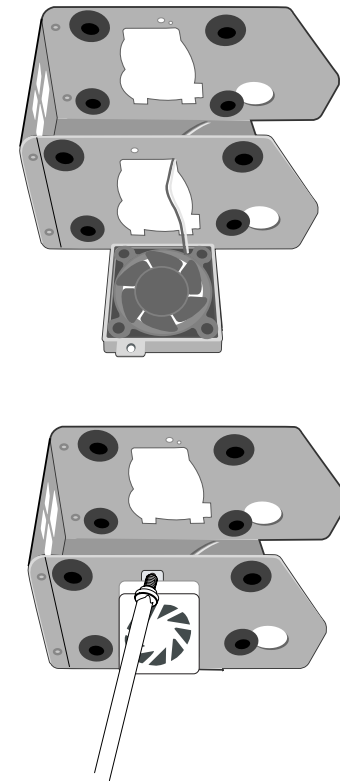

- ④ Fixing the fan to the left.

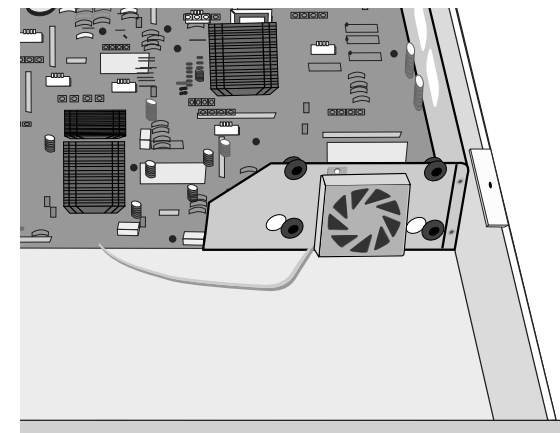



Chapter 3

Connecting with Other

Equipment

1 Connecting Video, Audio, & Monitor

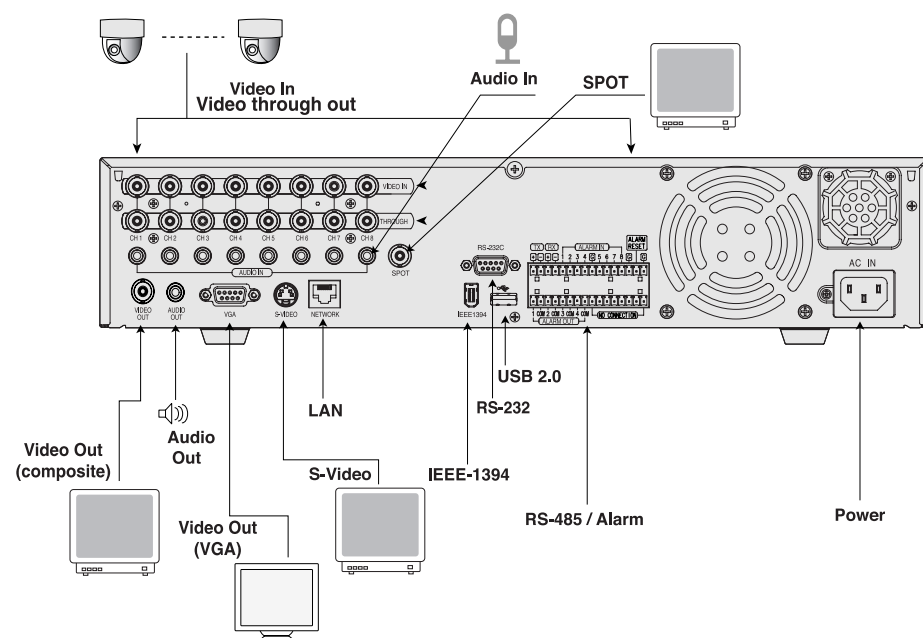

2 Connecting Network

- Connecting to Internet through Ethernet(10/100BaseT)

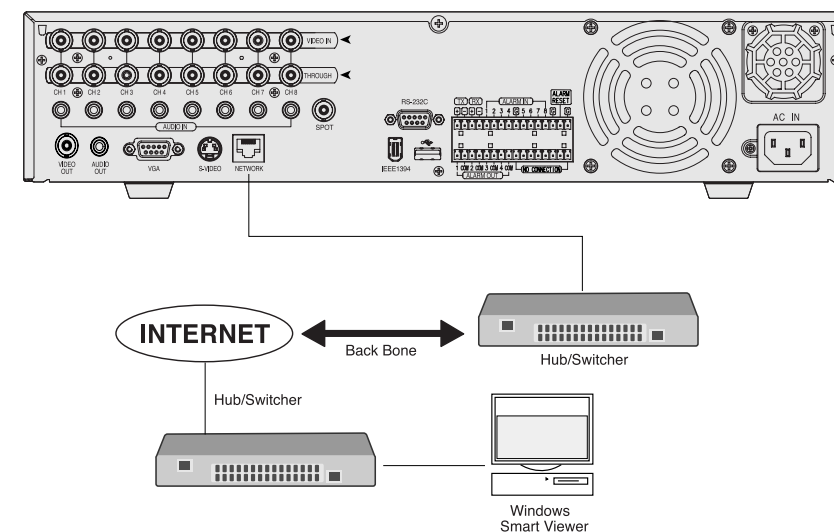

- Connecting Internet through ADSL

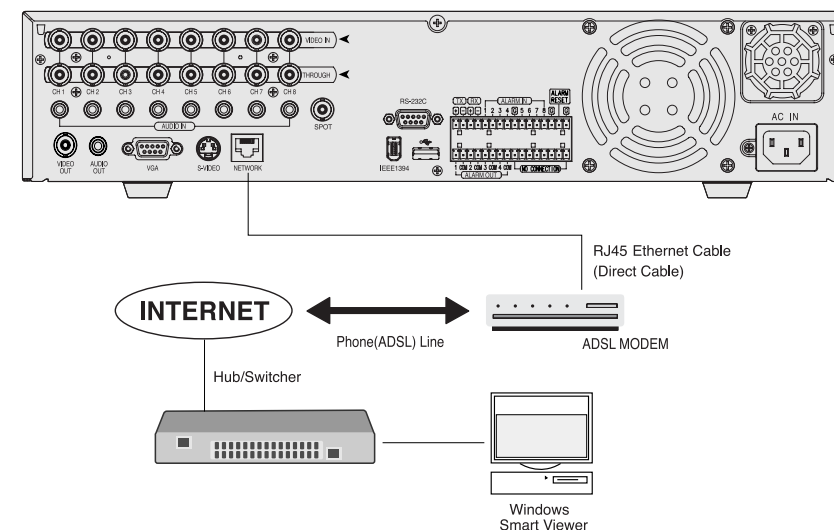

4 Connecting USB Device

1. A total of 2 USB connecting terminals are placed in front of and behind SHR4081N/P each.
2. Connect USB HDD, USB CD/DVD, and USB Memory through the ports in front and behind SHR-4081N/P respectively.
3. Only one USB device can be assigned to each USB connection port.
4. To recognize/ignore USB HDD, follow the procedure of Menu - System - HDD Setup upon connecting.
5. Supply the HOT PLUG function to connect/disconnect the USB device.
6. To recognize/ignore the HOT PLUG function, press Connect/Disconnect from Menu - System - HDD Setup.

Note

Refer to User's Manual 5-8, SYSTEM(HDD Setup).

⚠ Caution

- After enough time is given to the stabilization of the USB device connected by HOT PLUG, press Connect from SHR-4081N/P Menu.
- To disconnect the USB device, be sure to click Disconnect from SHR-4081N/P Menu. Otherwise, the USB device may be in trouble.
- Available to use with connecting the same kinds of USB device to the USB terminal on the front and back of SHR-4081N/P. (For example, 2 CD-RW or 2 USB memories can be connected to the front and back of SHR-4081N/P.)
- If the USB memory is used, it should be set to the format supported by SHR-4081N/P. Although it is formatted with FAT32 in the PC, it is re-formatted when it is connected to SHR-4081N/P.

⚠ Caution

- The USB device HDD shall be set to Master.

5 Connecting Alarm Input/Output

The Alarm IN/OUT port in the back of SHR-4081N/P is composed of the following elements.

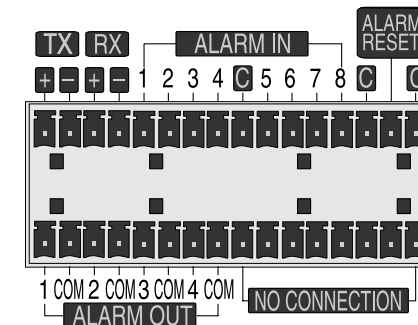

- ALARM IN/OUT Connection

	Name	Function
1	- ALARM IN1 - ALARM IN2 - ALARM IN3 - ALARM IN4 - ALARM IN5 - ALARM IN6 - ALARM IN7 - ALARM IN8	ALARM Input Port
2	- ALARM RESET IN	On receiving an ALARM RESET signal, the system cancels the current ALARM input or output signal and resumes sensing.
3	- ALARM OUT1 - ALARM OUT2 - ALARM OUT3 - ALARM OUT4	ALARM Output Port

- ALARM IN/OUT Connection

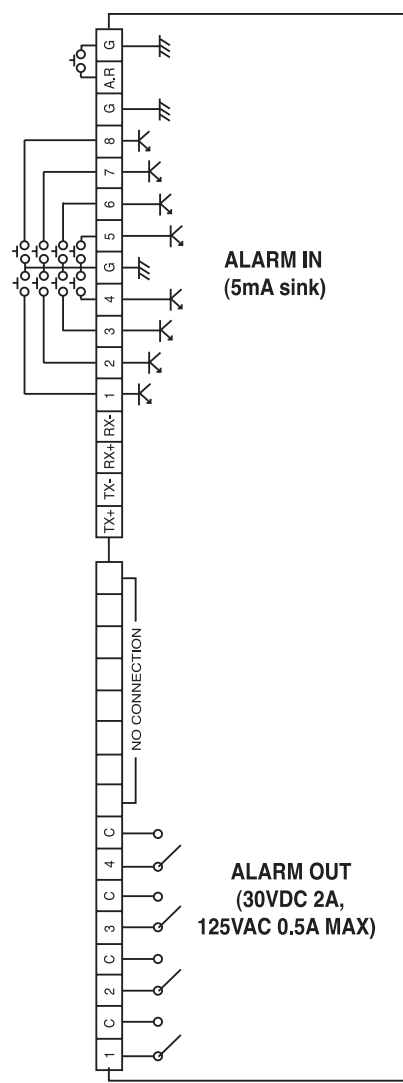

6 Connecting RS-485 Device

- Connect RS-485 Device through the back port of SHR-4081N/P.
- You can install and control the PTZ device supporting RS-485 communication.

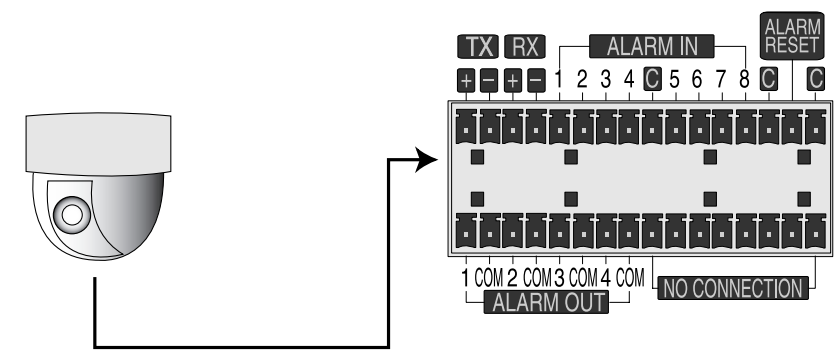

- You can adopt either Half Duplex or Full Duplex method for the connection.

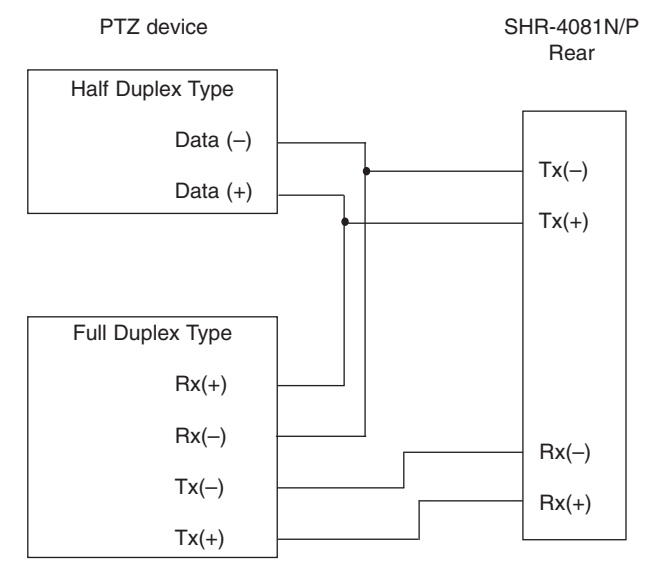

- Baud Rate covers 600, 1200, 2400, 4800, 9600, 19200, and 38400.

⚠ Caution

Check if RS-485 Device is compatible with SHR-4081N/P first. Then pay attention to the polarity of RS-485 which has two poles, + and -.



Chapter 4

Live

1 System Motion

- Turn the power on and the following LOGO screen pops up.



- After the LOGO screen appears, the button in front of SHR-4081N/P blinks 6 times to initialize the system for operation.
- When the initialization is complete, the live video appears along with a beep sound.
- It requires 30 to 40 seconds until the Live screen appears.

Note

A new HDD may require more time for the initialization until the Live screen appears due to the initialization period of the new HDD.

If the Live screen does not appear at all or the button in front of SHR-4081N/P repeats blinking, please check the connection across the product body. If you find any error, please ask the shop where you bought the product.

- The Live screen does not affect the earlier MENU setup. If you reboot the system after power-off during recording, the Live screen will appear, accompanying recording.

Note

If you see no more Live screen, you shall check if video data comes out in Composite mode or VGA mode.

If you wish to change the video output mode, you shall hold on to the MODE button in front of SHR-4081N/P and keep pressing the 0 button for 5 seconds. Press '0' button for 5 seconds with pressing the front mode button to change video output mode. After 3 times flickering of PTZ LED on the front left, it reboots.

2 Live screen Mode

Definition of Live Screen Icon

The Live screen icons of SHR-4081N/P display the current setup and function status of each screen.

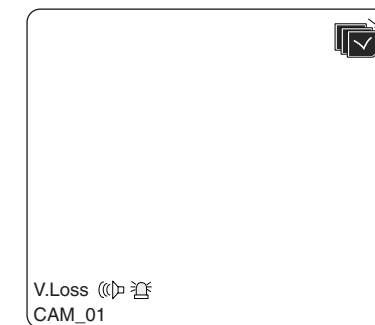
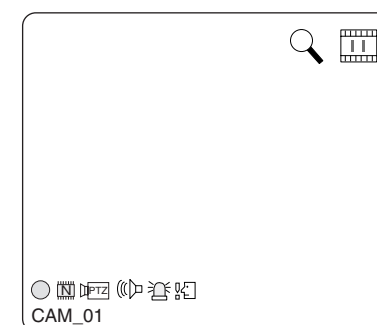

: Recording Icon
Each icon represents Normal / Panic / Event(Alarm+Motion) / Schedule Recording.

: Recording Video Size Icon
Each icon represents the recording size of Large/ Normal/ CIF
Large : Full D1(NTSC : 720 x 480 / PAL : 720 x 576)
Normal : Half D1(NTSC : 720 x 240 / PAL : 720 x 288)
CIF : CIF(NTSC : 352 x 240 / PAL : 352 x 288)

: PTZ Icon
This icon appears when you set up PTZ device with the PTZ icon and turns yellow when you execute PTZ.

: Audio Icon
This icon represents Audio On/Off status and turns yellow for On. It does not appear for Video or Audio Disable.

: Sensor In Event Icon
This icon appears in the channel synchronized with the external sensor signal input with Sensor On.





: Motion Event Icon
This icon appears in the Motion Event channel with Motion Detection On.

: Zoom Icon
This icon appears with Zoom On or Zoom In and disappears when you cancel Zoom On.

: Freeze Icon
This icon appears in the Freeze mode and disappears when you cancel Freeze.

: Insufficient Disk Space Icon in CH
More than one channel has insufficient recording space.

: Insufficient Disk Space Icon in all CHs
All the channels have insufficient recording space.

-  : Screen change Icon
This icon appears in the Screen change mode.
-  : Backup playback icon
It is displayed when the backup data plays.
-  : Fan fail Icon
It is displayed when the fan stops.
-  : It is displayed when there is no HDD.

V.Loss / V.Off : Video Input Status

If there is no more video data input with Video On, [V.Loss] appears in the channel.
If you set Video On/Off to Off, [V.Off] will appear.

Definition of Live Screen Mode

SHR-4081N/P receives 8 live images and displays them in the following 8 modes.

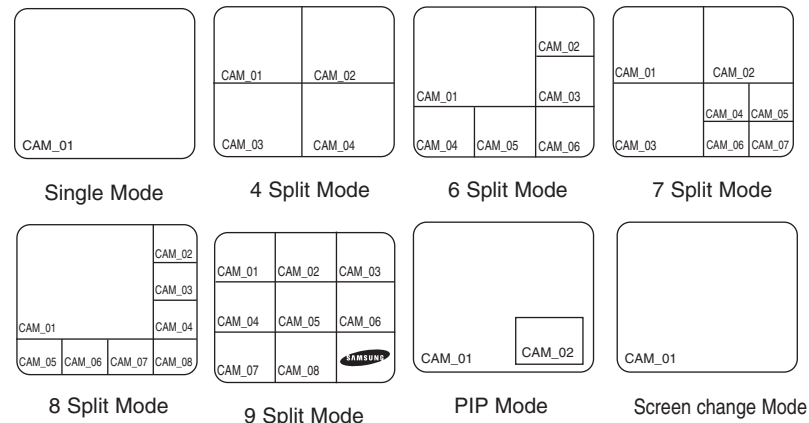

- **Full Screen(Single) Mode:**
Displays the selected channel in a full screen. Then, the channel LED concerned will be turned on.
- **4,6,7,8 Split Mode:**
Displays 4, 6, 7, 8, and image channels in the respective split screen and the CH LED lights on to indicate the channel no. You may match channel numbers with split screens on your own.
The 4CH Split mode has the function of screen change. Refer to (4-4) Live Screen Mode Setup. Press the [Direction Control] button in the 8CH Split mode and the main screen(CAM_01 in the figure) will move.
- **PIP(Picture in picture) Mode:**
Displays a one-ninth sized screen in the full screen and the channel LED concerned is turned on. You are able to choose a channel as you want to, which is displayed in the full screen or reduced screen area. You may move the PIP screen at 5 stages in the Full screen with the ▲ or ▼ key.
- **Screen change Mode:**
Displays the time when FULL SCREEN has been set to each channel in sequence and the channel LED concerned is turned on.

Selecting Live Screen Mode

Each mode may be selected by [MODE Button] and [CH1 ~ CH8 Button]
The following figure shows Live Mode of SHR-4081N/P after converted.

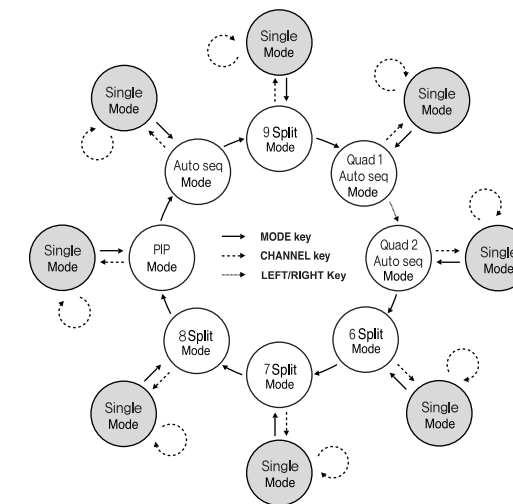

- The default is 9 Split Screen Mode.
- [1 CH ~ 8 CH] are displayed in the 9 split mode.
- Whenever the LEFT/RIGHT button is pressed, [4 Split 1 . 4 Split 2 .] in order in the 4 split mode.
- Other modes than Full Screen may be selected by pressing the [Mode] button and [← , →] button in sequence.
Every time you press the [Mode] button, the mode changes in the following procedure, [16Split] → [9Split 1] → [4Split 1] → [6Split] → [7Split] → [8Split] → [PIP] → [Screen Mode] → [16Split].
Every time you press the [← , →] button, the mode changes in the following procedure, [9Split 1, 2, Screen Mode], [4Split 1, 2, 3, 4, Screen Mode].
- Press the [CH1~CH8] button to see the full screen of each channel.
- Press the Mode button after you convert to a full screen in the Split Screen mode to returns to the previous Split mode screen.

3 Live Channel Selection and Audio On/Off Setup

In other split modes than Full Screen Mode, 9 Split Mode, and Screen change Mode, you may choose a channel to be displayed in each split area on your own. Meanwhile, the channel whose MENU is set to Audio On can set up Audio On/Off in all Live Modes.

Selecting Audio On/Off from the Full Screen mode

In the Full Screen mode, the selected CH Audio is automatically turned on and you can toggle the CH button to turn Audio on/off. The Audio icon turns yellow/white depending on Audio On or Off.

9 Selecting Audio On/Off in the Split mode

9 If you press [Enter] in the Split mode, the following cursor will appear and the channel will be selected. Press the CH button with a channel selected to set Audio on/off. Now, the Audio icon turns yellow/white depending on Audio On or Off.

16 You may not choose a channel in the Split mode on your own.

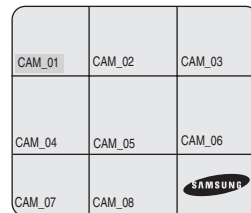

CH Selection and Audio On/Off Setup in the 4, 6, 7, 8 Split mode and PIP mode

As in the 9 Split mode, if you press [Enter] in the 4,6,7,8 Split mode and PIP mode, the selected cursor will appear and the channel will be selected.

With a channel selected, press [CH1 ~ CH9] to select the channel in the screen. As in the 9 Split mode, use the CH button LED to make Audio on/off setup. Now, the Audio icon turns yellow/white depending on Audio On or Off.

4 Freeze and Zoom

Freeze Function

Freeze pauses the video image in Live Screen, only available in Live Mode. You can set up Freeze On/Off with [FREEZE] button and [FREEZE LED] is turned on or off depending on the Freeze On/Off setup condition.

Zoom Function

Zoom enlarges the selected area twice, only available in Full Screen Mode.

If you press [ZOOM] button in Full Screen Mode, the zoomed area will appear now you are able to adjust the selected area position. If you select an area and press [ENTER] button, the area will be displayed in double size. If you press [ENTER] button again, the previous screen to select Zoom area will appear again and you will be capable of Zoom Off with [ZOOM] button after the screen is enlarged. Depending on the Zoom On/Off setup condition [ZOOM LED] is turned on or off.

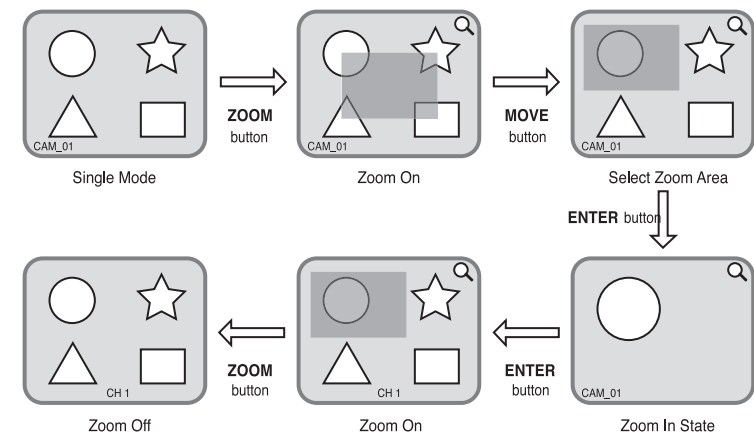

5 Event Monitoring

Event Monitoring displays the channel synchronized with a specific event (Sensor/Motion/Video Loss) on the screen when it occurs. Event Monitoring On/Off and Event Duration setup is available in [Menu]→[Monitoring].

If you set the Event Monitoring interval to 5 seconds and an event occurs at CH2 in the beginning as in the following figure, the system will display CH2 in the whole screen for 5 second. Another event within 5 seconds will be displayed together with the existing event. In the following figure, both CH1 and CH3 events occur within 5 seconds (for example, in 4 seconds) after the CH2 event, the three events are split into 4 screens.

Likewise, CH2, CH5, and CH7 events within 5 seconds after both CH1 and CH3 events are integrated with the existing 2 events and all the 5 events are split into 9 screens. Without further event during Event Duration, the system will return to the previous Live Mode.

If you press [ALARM] button during Event Duration, Event Monitoring will stop. On sensing an event, [ALARM LED] is turned on. If you press [ALARM] button now, [ALARM LED] will go out.

Press [ALARM] to reset the Alarm setting. The Event icon will disappear and this function will be cancelled during Event monitoring. When the Event recording time, Pre-Alarm time, and Post-Alarm time were already set after an alarm had been given, Event recording will be done for the set period.

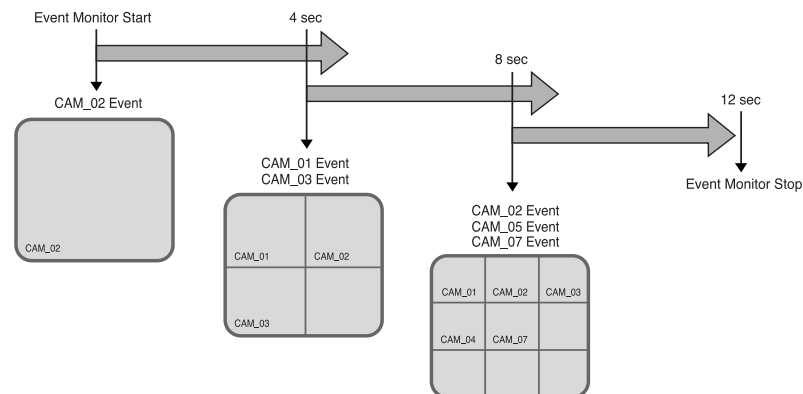

6 Spot-out Monitoring

Spot-out Monitoring has nothing to do with Live Screen Output, monitoring the full screen of a certain channel. If you select Monitoring in the MENU screen, you can make a channel among CH1 to CH8 spot out or you can output channels one by one at an interval as Screen change Mode of Live Mode. The interval is as same as the forwarding time of Screen change Mode of Live Mode. If you set Spot-out Event Monitoring to On, you will be able to spot out the event channel. In case of simultaneous event occurrence at more than one channel, the lowest numbered event channel has the first priority to be spotted out.

! Caution

If the built-in HDD is not connected, or it operates with power applying in error, () indicating "built-in HDD error" is displayed at the top of left. At this time,

- (1) Live screen mode
- (2) Monitoring mode by Smart Viewer

operate only and the other functions including recording, search, playback, menu setup, and PTZ do not operate.

If the above problem is occurred, Be sure to contact a service center to settle the problem.

! Caution

If the fan of set is not operated or occurs an error, the following error message is popped up in the live screen. And the fan error icon is displayed at the left upper. Check the fan of set in this time. The left upper icon is disappeared automatically if the fan operates normally.

Fan Information



Fan is in trouble.
Refer to the Manual.



Chapter 5

Menu Setup

Before Use

- Selection
The yellow cursor shows the current window.
Use the ▲, ▼, ◀, ▶ button in the front to move the cursor on your desirous menu.
If you press the “Enter” key with the cursor clicking on your desirable menu, the system will enter the new mode.
Press the “Enter” key to finish selection.
On seeing Drop Down Menu, use the ▲ or ▼ button to move the cursor on your desirable menu.
- “OK” or “Cancel” in Menu Setup Window
Once changed, the new menu setup procedure will be finalized by pressing “OK”.
Pressing “Cancel” will cancel the previous setup and return to the upper menu.
- Front “MENU” and “SEARCH” Button
The MENU button or SEARCH button, if pressed first, acts as an entrance button.
Once entering, it reverses the page to the previous one.
- The “>” or “V” mark beside the title copies the line in the arrow direction to the value of the first line.
- The first page of the menu is structured as follows.

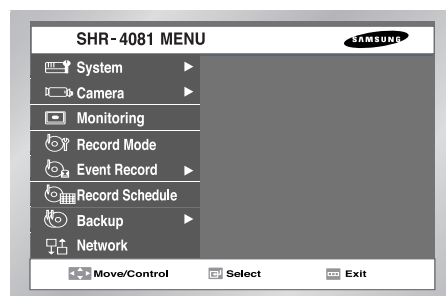

1 System

- System Menu has the following items in detail.



Date/Time/Language Setup

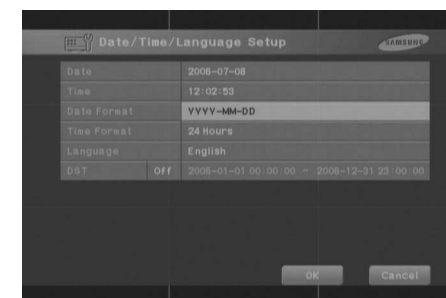

- Date
Press the “Enter” button and the ◀ or ▶ button to move to Y/M/D.
Use the ▲ or ▼ button to change the date.
Press the “Enter” button to come out of the mode.
- Time
Press the “Enter” button and the ◀ or ▶ button to move to H/M/S.
Use the ▲ or ▼ button to change the time.
Press the “Enter” button to come out of the mode. Once changed, the date and time will remain unchanged until you press “OK” or “Cancel”.

Note

[Date/Time Change]

Pressing "OK" after you change date and time, you will be asked by a pop-up window if you really confirm the change. Here, press "Yes" to change the time. Since Date/Time does not change in backup process, be sure to stop the backup process before you change Date/Time.

Caution

[Date/Time Change]

If you restore Date/Time to the original value, the data recorded before the restoration may be deleted. For example, if you restore 8 am to 7 am, all the data recorded between the times will be deleted.

- **Date Format**
This supplies 3 formats, Year-Month-Date / Date-Month-Year / Month-Date-Year.
- **Time Format**
This supplies 2 formats, 24 Hour / 12 Hour(AM/PM).
- **Language**
After you select a language, OSD is expressed in the selected language. The available languages are added in the list.
- **DST(Daylight Saving Time)**
DST sets the watch one hour faster than the local standard time. This makes the system count for DST in DST regions. Being the DST setup date, the set goes one hour faster and starts rebooting.

Set to Off, DST does not operate. Then, you are unable to enter the right date menu. Set to On, you can set the start time on the left and the end time on the right on the basis of '~'. DST is allowed to set Month/Date/Time only. Year/Minute/Second remains inactivated.

Note

[When the DST is operated]

The proceeding backup is cancelled. Recording in progress will be suspended for a moment until rebooting.

Caution

[When the DST is operated]

As the system goes one hour earlier, the data recorded since an hour ago will be deleted. As DST activates at the preset time, you are recommended to take the utmost care of preventing any trouble incurred by data deletion or rebooting.

Password

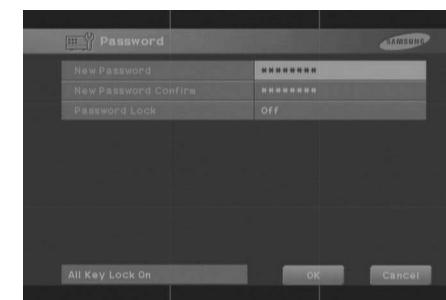

- The Default Password is 4321.
- **New Password**
This is used to change the system password inside SHR-4081N/P. You are allowed to create a password up to 8 digits. Press the "Enter" button and then a channel button from 0 ~ 9 on your left to finish input. If you press the "Enter" button after change, the system will automatically turn to "New Password Confirm".
- **New Password Confirm**
This confirms a new password. You shall be obliged to input New Password in the above row first. Without New Password input, New Password Confirm input has no effect.
- **Password Lock**
Pressing the "Menu" button while it is set to On, you will be asked by a pop-up window of the password. Pressing the "Menu" button while it is set to Off, you will enter Menu Mode immediately, not being asked of the password.
- **All Key Lock On**
If you select this, the system will enter Live Mode immediately. If you press a button in the front, the Password window will pop up. Succeeding in Password input will be followed by Key Lock cancellation after such a message window pops up.

Note

[All Key Lock On]

If you select this, the system will enter Live Mode immediately and keys will be locked.

Load Factory Default

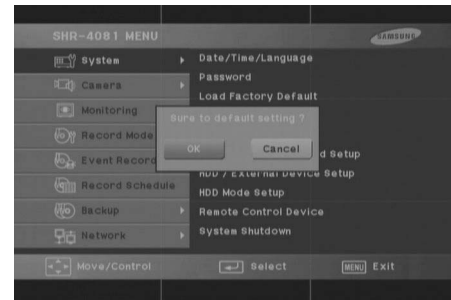

- This initializes all the menu preset values. The recorded data will not be deleted. Press “OK” in the confirmation window to start initializing.

System Log



- System Log is used by a controller to check crucial records.
- This displays such contents of a system related log and its execution date/time as System Start, System Termination, and Menu Setup Change.
- First : Returns to the first page.
- Prev : Back to the previous page.
- Next : Forwards to the next page.
- Last : Moves to the recent.

● System Log List

System Start	System Start	Panic Record End	Panic Recording End
Login(Admin)	Viewer Login (Admin)	Time Change	Date/Time Change
Logout(Admin)	Viewer Logout (Admin)	Load Factory Default	System Initialization
Login(User)	Viewer Login (User)	System Upgrade	System S/W Change
Logout(User)	Viewer Logout (User)	Disk Full	No Space for HDD
Setup Start (Local)	Set: Menu Entering	Backup Start	Backup Start
Setup End (Local)	Set: Menu Escape	Backup End	Backup End
Setup (Remote)	Viewer:Menu Setup	Backup Stop	Backup Stop
Play Back Start	Play Start	Backup Fail	Backup Failure
Play Back End	Play End	ATA HDD Erase	ATA HDD Data Deleted
Record Start CH[N]	Channel [N] Play Start	IEEE1394 HDD Erase	IEEE1394 HDD Data Deleted
Record End CH[N]	Channel [N] Play End	USB HDD Erase	USB HDD Data Deleted
Power Failure Recovery	System Restoration after Power Failure	Overwrite Playback Stop	Replay stop due to overwriting
Panic Record Start	Panic Recording Start	Backup Stop(Overwrite)	Backup stop due to overwriting

Event Log

- Checks the record regarding Event like Alarm / Motion / Video Loss
- This displays the contents of a log regarding Event its execution date/time.
- First : Returns to the first page.
- Prev : Back to the previous page.
- Next : Forwards to the next page.
- Last : Moves to the recent.

● Event Log List

Video Loss CH[N]	Channel N Video loss
Alarm Detection CH[N]	Channel N Alarming
Motion Detection CH[N]	Sensing Channel N Motion

System Information and Setup

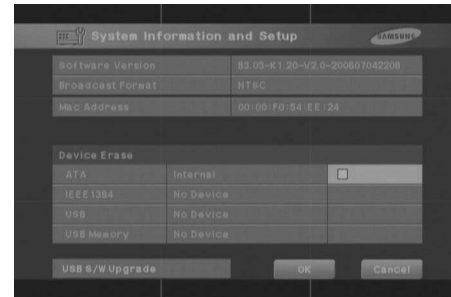

- Software Version : Displays the current version. Setup is not available.
- Broadcast Format : Displays the current Format(NTSC/PAL). Setup is not available.
- Mac Address : 6 Byte hardware address. Setup is not available.
- Device Erase
Erases the data in the ATA / IEEE1394 / USB / USB memory.
Check the box that you want to delete and press "OK".
Data is undeletable during Backup.
- USB S/W Upgrade
When there is no device, USB S/W Upgrade is failed.

Note 1

Being a physical hard disk inside the SHR-4081N/P main body connected by an IDE cable, this stores data.

[External HDD]

Being a physical hard disk connected with the port and terminal in the back of the SHR-4081N/P main body, this stores data.

This can be used as Extended HDD or Backup HDD.

- Extended HDD : Supplements Internal HDD quantity. Connected, it takes the place of Internal HDD.

- Backup HDD : Backs up the data recorded in the set.

Note 2

[ATA]

Usage : Internal HDD

This is a physical hard disk connected with SHR-4081N/P through the IDE cable.

[USB]

Usage : External HDD (Extended HDD or Backup HDD)

A physical hard disk connected with the USB port in the back of the SHR-4081N/P main body

[IEEE1394]

Usage : External HDD (Extended HDD or Backup HDD)

A physical hard disk connected with the IEEE1394 port in the back of the SHR-4081N/P main body

Note 3

[USB S/W upgrade]

1. You can download the data(tgz file) for upgrade from www.samsung.com, CCTV Part.

2. The USB memory should have only one tgz file for upgrade.

3. In case of other memory format than supported by SHR-4081 model, please delete the memory and set it up according to the set format.

⚠ Caution

[HDD Erase]

Data will not be deleted in backup or recording process.

Please be sure to suspend backup or recording before you delete any data.

If the recording is in progress, stop the recording to delete a data.

[USB S/W Upgrade]

You may download the software for upgrade from CCTV Part of <http://www.samsung.com>.

If the USB memory to be upgraded is not in a format supported by the DVR set, the upgrade cannot be done. In this case, please use "Remove Devices" from "System Information and Settings" in Menu 5-7. There should be only one file for upgrade in the USB memory.

HDD/External Device Setup

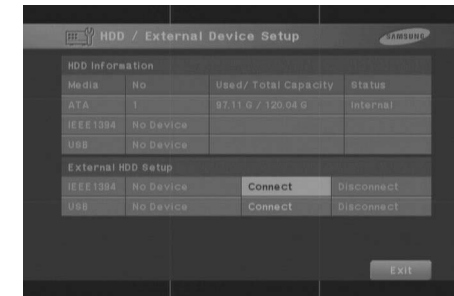

- HDD Information
Displays the number, quantity, and status of ATA, IEEE1394, and USB.
Setup is not available.
Status : Internal HDD, External HDD, Backup HDD
- External HDD setup
 1. Backup/External
You are able to determine the usage of IEEE1394 and USB.
Not Defined → When the connected HDD usage is not defined.
Expressed in External or Backup.
No Device → When no HDD is connected. You are able to press right TAB after you connect HDD.
External → When the connected HDD is set to External. It may used as a back up HDD if you press the "Enter" button and turn to Backup.
Backup → When the connected HDD is set to Backup. It may used as an External HDD if you press the "Enter" button and turn to External.
 2. Hot Plug - Connect/Disconnect
You may connect or disconnect IEEE1394 Hard Disk while power is supplied to the SHR-4081N/P main body.
 - ① As for connecting, connect IEEE1394 Hard Disk with the SHR-4081N/P main body and press "Connect". Pressing "Connect" makes the SHR-4081N/P main body recognize all connected IEEE1394 Hard Disks.
 - ② As for disconnecting, be sure to press "Disconnect" and detach IEEE1394 Hard Disk from the SHR-4081N/P main body safely.(Be sure to pause recording or backup process.) Pressing "Disconnect" cancels and detaches all connected IEEE1394 Hard Disk.

Caution

[IEEE-1394 Hot-Plug Connect/Disconnect Function]

Both IEEE1394 and USB support Hot-Plug.

[Backup HDD]

You may set both the USB and IEEE1394 device as the Backup HDD.

HDD Mode Setup

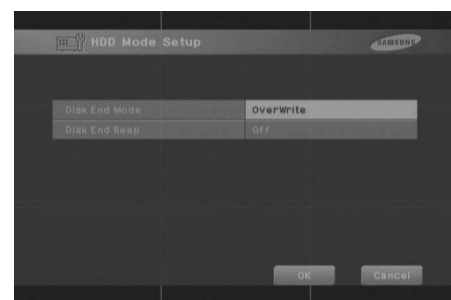

- **Disk End Mode**
Stop : Stops recording when HDD is full during recording.
Overwrite : Deletes the original data and save a new data when HDD is full during recording.
- **Disk End Beep**
On : Beeps when HDD is full during recording.
Off : When HDD is full, the beep sound is not heard.

Caution

[Disk End Mode Overwrite]

In the Overwrite mode, delete the old Event data in advance.

Remote control Device

- MENU for Samsung Integrated Remote Control(SSC-2000)

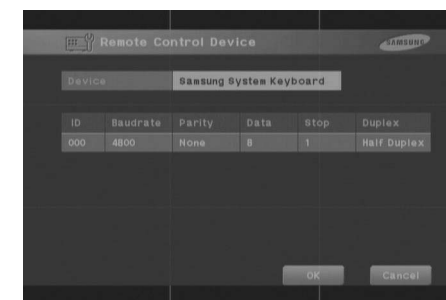

- **Device**
A Remote Control Device, being connected to the RS485 port.
- **ID**
Unique ID of SHR-4081N/P
This unique ID is essential as SSC-2000 can control multi SHR-4081N/P DVRs.
- **Baudrate**
Baudrate to communicate with SSC-2000
Be sure to be identical to SSC-2000 Baudrate for communication.
- **Parity**
Sets up one of None / Even / Odd.
- **Data**
Sets up either 7 or 8.
- **Stop**
Sets up either 1 or 2.
- **Duplex**
Sets up either Half Duplex or Full Duplex.

Note

If you select Remote Control Device, you may not PTZ device with SHR-4081N/P. The PTZ button in front of SHR-4081N/P becomes inactivated. Press the PTZ button and the PTZ ban icon() will appear. It's because the RS-485 port setup was done for Remote Control Device.

2 Camera

System Shutdown

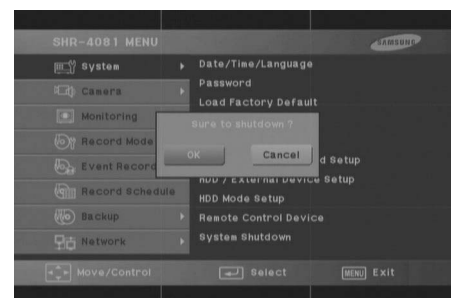

- Terminates the work in action safely and turns the power off. Press "OK" in the confirmation window and plug out when you see "Safe to Power Off".

! Caution

[System Shutdown]

Power-off without terminating the system in the System Shutdown menu may incur improper motion like data loss and disk failure. Power-off shall be done in the System Shutdown menu.

- The detailed Camera Menu items are as follows.



Camera Configuration



- Video**
 On : Camera images from a selected channel appear.
 Off : Camera images from a selected channel disappear.
 Covert1 : Displays other information than the image information on the selected channel.
 Covert2 : Hides all the information on the selected channel.
 In this case, you are not allowed to set Audio/Title/Screen change.
- Audio**
 On : You can hear voices from a selected channel.
 Off : You cannot hear voices from a selected channel.

- Title
You can name the camera of a selected channel.
If you press the [Enter] button, the Virtual keyboard will come out.
 - ▶ Virtual Keyboard
If you move the cursor, you can type text by text.
Up to 15 texts can be typed.
Keyboard cannot be composed of all spaces.
Pressing Caps Lock changes the keyboard that can be selected. (2 Modes)



- Auto Seq.
You may define the duration of each channel at the Screen change channel in Live Mode. A channel, set of Off, does not operate in Screen change Mode.

PTZ Device



- ID
PTZ device ID from 0 to 255
- Protocol
A protocol supported by PTZ device
The following protocols are now being supported.
Samsung / Vic. / Pan. / AD / Phi. / Ern. / Pel-D / Pel-P / Vcl. / Dia. / Kal.
- Baudrate
Baudrate supported by PTZ device , 600 / 1200 / 2400 / 4800 / 9600 / 19200 / 38400
- Parity
Defines one among None, Even, and Odd.
- Data
Defines either 7 or 8.
- Stop
Defines either 1 or 2.
- Serial Mode
Defines either Half Duplex or Full Duplex.

Caution

*The above items shall be aligned with the PTZ device setup condition.
For the details, please refer to User's Manual of the PTZ device manufacturer.*

3 Monitoring

Screen Setup



- This is a window to adjust Brightness/Contrast/Color for the camera image of each channel. Put the cursor on the channel that you want to adjust and set up Brightness/Contrast/Color. Once selected, the channel appear in the PIP area on the right. Press the ▲ or ▼ button to adjust the value from 0 to 100.
- If you select CH ✓, all the channel values will become the same as the finally selected channel value.
- "Default" resets the current channel to the basis value of 50.

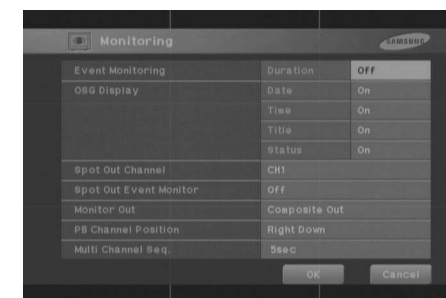

- **Event Monitoring**
You are able to set to Off / 3sec / 5sec / 10sec / 20sec / 30sec / Continuous.
 - ① Off : Event Monitoring does not operate to turn to the screen where an event occurs.
 - ② 3sec / 5sec / 10sec / 20sec / 30sec : For the period, the screen is seen before the next screen appears.
 - ③ Continuous : The Event Monitoring screen remains alive until you press the front "Alarm" button to cancel the screen manually.
- **OSG Display**
 - ① Date : The date is displayed on the screen or not depending Date remains On or Off.
 - ② Time : The time is displayed on the screen or not depending Time remains On or Off.
 - ③ Title : The title is displayed on the screen or not depending Title remains On or Off.
 - ④ Status : Audio/Ptz is displayed on the screen or not depending Status remains On or Off.
- **Spot Out Channel**
Spot Out channel is used to let one of two monitors monitor a channel, focusing on it. Spot Out channel supplies two functions, continuous monitoring of only one channel and Screen change to display all the channels one by one.
 - ① Screen change setup ranges from CH1 to CH8.
 - ② Set to Screen change, Spot Out channels are displayed in turn.
 - ③ Screen change Duration is as same as determined for Camera Configuration.
- **Spot Out Event Monitor**
Determines if event monitoring will be executed for Spot Out channels.
 - ① Off : dose not event monitoring in Spot out channel.
 - ② 3sec / 5sec / 10sec / 20sec / 30sec : Duration options on the screen before it scrolls down.
 - ③ Continuous : Once scrolled down, the screen remains displayed until you delete "Alarm" LED in front manually.

4 Record Mode

- **Monitor Out**
You may not use both VGA Output and Composite/S-Video Output at the same time. Accordingly, the user shall choose either one.
 - ① Composite : The output will come out from the "Composite / S-Video Output" port.
 - ② VGA : Output comes out of the "VGA Out" port.
Any change from Composite to VGA or vice versa reboots the system automatically.
- **PB(Playback) Channel Position**
Designates the position of a channel to be played back in Play Back 9 Split Mode.
Right Down : Designates a location on the bottom right corner.
Center : Designates a location in the center.
- **Multi-channel Seq.**
The change of split screen is available to be set.
It can be set to Off ,3 Sec,5 Sec, 10 Sec, 20 Sec, 30 Sec.

⚠ Caution

[Monitor Out]

Set to Composite Output, VGA does not come out.

Set to VGA, Composite Output does not come out.

If you hold on to the MODE button in Live Mode and keep pressing the 0 button for 5 seconds, the status will change from VGA to COMPOSITE or vice versa accompanying rebooting.

NTSC

Case	Mode	Video Size	Quality	Rate
1	On	Full D1	Very High	7.50 ips
2	On	Half D1	Low	15.00 ips
3	On	Half D1	Very High	15.00 ips
4	On	Half D1	Very High	15.00 ips
5	On	Half D1	Very High	7.50 ips
6	On	Half D1	Very High	7.50 ips
7	On	Half D1	Very High	7.50 ips
8	On	Half D1	Very High	7.50 ips

Auto Deletion :
Off 30 Day OK Cancel

PAL

Case	Mode	Video Size	Quality	Rate
1	On	Full D1	Very High	6.25 ips
2	On	Half D1	Low	8.33 ips
3	On	Half D1	Very High	8.33 ips
4	On	Half D1	Very High	8.33 ips
5	On	Half D1	Very High	8.33 ips
6	On	Half D1	Very High	8.33 ips
7	On	Half D1	Very High	8.33 ips
8	On	Half D1	Very High	8.33 ips

Auto Deletion :
Off 30 Day OK Cancel

If you press the front "REC" button, the mode to be recorded will be determined.

- For Event Recording Mode value setup, refer to 5-19. Event Record Mode Setup Menu.
- **Mode**
On : Pressing the REC button starts recording the current channel.
Off : Even pressing the REC button does not affect current channel recording. The default is set to "On".
- **Video Size**
Determines the size of a screen to be recorded.
Full D1 : 720 x 480(NTSC) / 720 x 576(PAL) → Large(L)
Half D1 : 720 x 240(NTSC) / 720 x 288(PAL) → Normal(N)
CIF : 352 x 240(NTSC) / 352 x 288(PAL) → CIF(C)

Note

[Video Output]

"Full D1" setup for the resolution is available from the recording sheet number of 7.5ips(NTSC)/6.25ips(PAL)

"Half D1" setup for the resolution is available from the recording sheet number of 15ips(NTSC)/12.5ips(PAL)

Resolution "CIF" can be set from Recording page number "30."

- **Recording Resolution**
Selects the recording resolution. VH(Very High) / H(High) / S(Standard) / L(Low).
- **Rate**
Determines Frame Rate to be recorded. Frame Rate means the number of screen recorded every second.
Set to 30ips(NTSC)/25ips(PAL), the system records too many screens per second and play continues intermittently since recording is more detailed. This is appropriate for concentrated monitoring zone setup.
Set to the one of 30ips / 15ips / 10ips / 7.5ips / 5ips / 3ips / 1ips (NTSC)
Set to the one of 25ips / 12.5ips / 8.33ips / 6.25ips / 5ips / 2.5ips / 1ips (PAL)
- **Auto Deletion**
Click [Off] button at the left bottom to select Off/On.
Select On to limit the search date by moving to the date selecting button.
Select Off not to limit the search date.
The date is limited from 1 to 99.

5 Event Record Mode

- The detailed items of Event Record Menu are as follows.

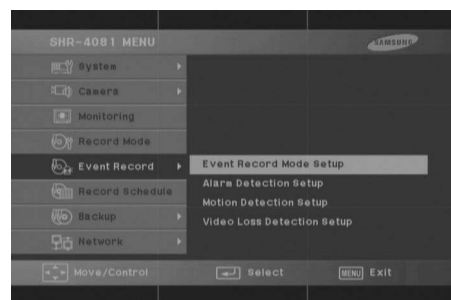

Event Record Mode

NTSC

Case	V.Size	Quality	Rate	PreEve	PostEve
1	CIF	High	7.50 ips	Off	10sec
2	CIF	standard	15.00 ips	Off	10sec
3	CIF	Low	15.00 ips	Off	10sec
4	CIF	Very High	15.00 ips	Off	10sec
5	CIF	Very High	15.00 ips	Off	10sec
6	CIF	Very High	15.00 ips	Off	10sec
7	CIF	Very High	15.00 ips	Off	10sec
8	CIF	Very High	15.00 ips	Off	10sec

PAL

Case	V.Size	Quality	Rate	PreEve	PostEve
1	CIF	High	12.5 ips	Off	10sec
2	CIF	standard	12.5 ips	Off	10sec
3	CIF	Low	12.5 ips	Off	10sec
4	CIF	Very High	12.5 ips	Off	10sec
5	CIF	Very High	12.5 ips	Off	10sec
6	CIF	Very High	12.5 ips	Off	10sec
7	CIF	Very High	12.5 ips	Off	10sec
8	CIF	Very High	12.5 ips	Off	10sec

Determines a mode to be recorded when an event occurs.

- V. Size (Video Size)**
Determines the size of a screen to be recorded.
Full D1 : 720 x 480(NTSC) / 720 x 576(PAL) → Large(L)
Half D1 : 720 x 240(NTSC) / 720 x 288(PAL) → Normal(N)
CIF : 352 x 240(NTSC) / 352 x 288(PAL) → CIF(C)

- Quality**
Recording resolution will be determined.
VH(Very High) / H(High) / S(Standard) / L(Low).

Note

"Full D1" setup for the resolution is available from the recording sheet number of 7.5ips(NTSC)/6.25ips(PAL)
"Half D1" setup for the resolution is available from the recording sheet number of 15ips(NTSC)/12.5ips(PAL)
Resolution "CIF" can be set from Recording page number "30."

- Rate**
Determines Frame Rate to be recorded. Frame Rate means the number of screen recorded every second.
Set to 30ips(NTSC)/25ips(PAL), the system records too many screens per second and play continues intermittently since recording is more detailed. This is appropriate for concentrated monitoring zone setup.
Set to the one of 30ips / 15ips / 10ips / 7.5ips / 5ips / 3ips / 1ips(NTSC)
Set to the one of 25ips / 12.5ips / 8.33ips / 6.25ips / 5ips / 2.5 ips / 1ips(PAL)

- Pre-Event (PreEve.)**

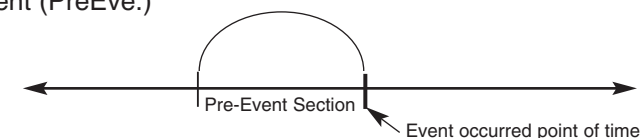

Records the situation until Event is issued.

Off : No recording

5sec / 10sec / 20sec / 30sec : The recording time options before Alarm issue

- Post-Event (PostEve.)**

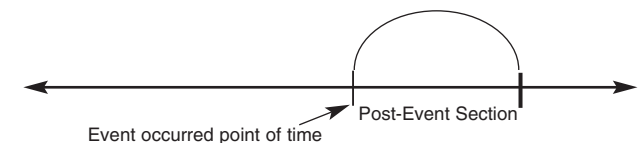

Records the situation since Event is issued.

Off : No recording

5sec / 10sec / 20sec / 30sec / 1min / 3min / 5min / 10min / 20min :

To this, the recording time after Alarm issue is set.

Alarm Detection Setup

- **Sensor State**
 Off : Sensor does not operate.
 - ① N.O(Normal Open) Sensor : Sensor remains open all the time and if closed, an alarm will be issued. (A Contact)
 - ② N.C(Normal Close) Sensor : Sensor remains closed all the time and if open, an alarm will be issued. (B Contact)
- **Cam**
 Determines a camera which will synchronize with the current sensor.
 The default is currently set to the sensor number. A sensor shall be synchronized with at least a camera. Multi-synchronization is possible.



- **Alarm-Out**
 Arranges Alarm-Out when Alarm Sensor sounds.
 At this moment, this supports 5 Alarm Outs. Choose an alarm-out that you want to synchronize with the current sensor. Multi-choice is possible.

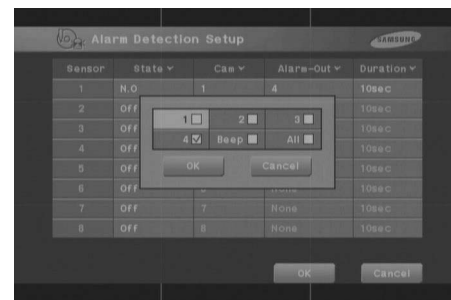

- **Duration**
 Determines Alarm-Out Duration. Alarm-Out continues for the determined duration.
 Off / 3sec / 5sec / 10sec / 20sec / 30sec

Motion Detection Setup



- **M.D State**
 Off : Motion Detection does not operate
 On : Motion Detection starts operation.
- **Area**
 Select the Motion Detection zone. It is composed of 45x40(NTSC) / 45x48(PAL) sized Block. You are forbidden to determine 4 block rows(Up/Down/Left/Right) to allow them to be displayed in all monitors.
 - ▶ Select All : Selects the whole area.
 - ▶ Select One : Selects a block every time. Selection is done by a toggle system.
 - ▶ Select Quarter : Split the whole area into 4 pieces, which enables selecting a fourth of the whole area.
 - ▶ Clear All : Cancels the whole area.
 - ▶ Save & Exit : Saves and exits.
 - ▶ Exit : Exits without saving.

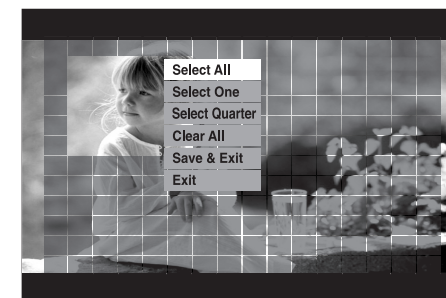

6 Record Schedule

- **Sensitivity**
Determines Motion sensing sensitivity. Sensitivity grade consists of Low → Medium → Very High in the ascending order.
- **Alarm-Out**
Selects Alarm-Out scope when Motion occurs.
At this moment, this supports 5 Alarm Outs. Choose an alarm-out that you want to synchronize with the current motion channel. Multi-choice is possible.
- **Duration**
Determines Alarm-Out Duration. Alarm-Out continues for the determined duration.
Off / 3sec / 5sec / 10sec / 20sec / 30sec

Video Loss Detection Setup



- **Video Loss State**
Off : Image Loss Sensing does not operate.
On : Image Loss Sensing starts operation.
- **Alarm-Out**
Selects Alarm-Out scope when the current Image Loss occurs.
At this moment, this supports 5 Alarm Outs. Choose an alarm-out that you want to synchronize with the current motion channel. Multi-choice is possible.
- **Duration**
Determines Alarm-Out Duration. Alarm-Out continues for the determined duration.
Off / 3sec / 5sec / 10sec / 20sec / 30sec

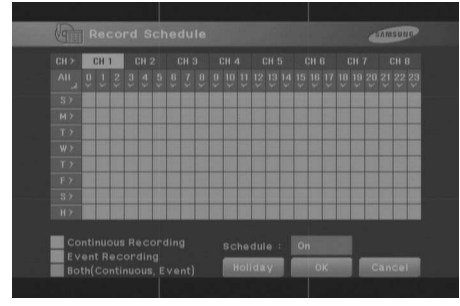

You may select a time when recording starts automatically. Setup by the weekday or time. The default is set to "None".

- Pressing "CH >" copies the value of Channel 1 to all the channels.
- The horizontal axis numbered from 0 to 23 represents the time value. The vertical axis numbered from S to H represents the day value. (H : Holiday)
Setup by the weekday or time.
- Pressing "ALL" converts the overall setting of the selection window into Continuous → Event → Both → None.
- **Continuous Recording**
Recording starts automatically on the preset time.
Recording follows the condition established in 5-18.Record Mode of MENU.
☛ Refer to 7-3 Record Schedule of MENU.
- **Event Recording**
Recording starts automatically when Event occurs to Alarm/Motion Detection/Video Loss within a designated time.
Recording follows the condition established in 5-19.Event Record Mode Setup of MENU.
☛ Refer to 7-4 Event Recording of MENU.
- Each recording mode has its unique color, Yellow for Sleeping, Blue for Event, and Red for Sleeping/Event.
- **Reserved Recording On/Off**
The reserved recording will progress when it's set to "On," and the reserved recording will not progress when it's set to "Off."

7 Backup

- Both(Continuous, Event)
On occurrence of Event, Continuous Recording is replaced with Event Recording Mode.
- Holiday
If you press "Holiday", a calendar pops up and you are able to designate holidays. Move to a date and press "Enter" to complete designation. Press "Enter" once more to cancel designation. "H" at the bottom of the table means a holiday.

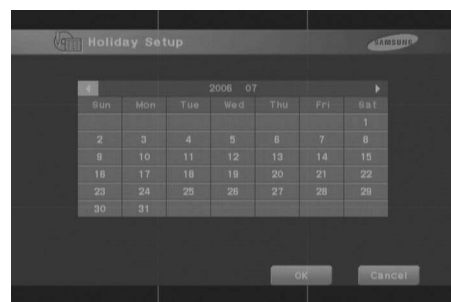

- The detailed items of Backup Menu are as follows.

HDD Backup Settings

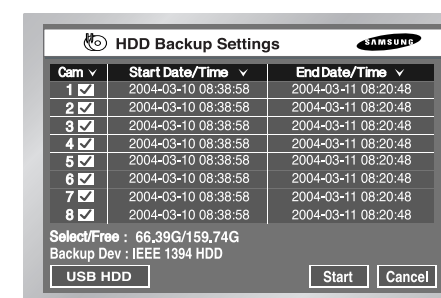

- In the presence of the device, the free space and backup device will be displayed.
- Select the backup date and time and the camera number, then press "Start".
- Whenever you change the start date/time, the end date/time, the free space is updated and displayed.
- In case that two devices are connected, select the backup device by clicking the USB HDD box at the left bottom.
- In the absence of the backup device, a warning message appears. Select and connect the backup device in Menu 5-8, HDD Setup before the backup process.
- Press "Stop" to suspend backup.
- Press "Cancel" during backup to return to the upper menu but the process continues nevertheless.

Caution

*[In the Backup process]
Press "Cancel" to return to the upper menu but the process continues nevertheless.
Press "Stop" to suspend backup
Backup may retard the normal set speed.*

8 Network

USB Device Backup Settings

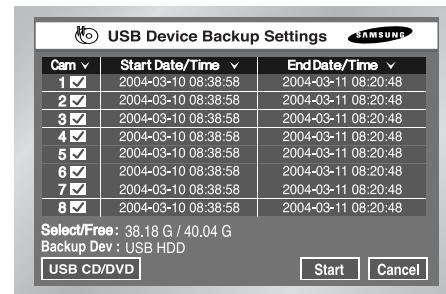

- In the presence of the device, the free space and backup device will be displayed.
- Select the backup date and time and the camera number, then press "Start".
- Whenever you change the start date/time, the end date/time, the free space is updated and displayed.
- In case that two devices are connected, select the backup device by clicking the USB CD/DVD box at the left bottom.
- In the absence of the backup device, a warning message appears.
Select and connect the backup device in Menu 5-8, HDD Setup before the backup process.
- Press "Start" to suspend backup.
- Press "Cancel" during backup to return to the upper menu but the process continues nevertheless.

! Caution

*[In the Backup process]
Press "Cancel" to return to the upper menu but the process continues nevertheless.
Press "Stop" to suspend backup
Backup may retard the normal set speed.*

IP Settings



- **Connection Mode**
Designates the kind of the network connected to the main body of SHR-4081N/P.
Static IP : When the main body is connected to the network with Static IP.
Dynamic IP : When the main body is connected to the network with Dynamic IP supplied by DHCP.
ADSL(PPPoE) : When the main body is connected to the ADSL network with PPPoE.
- **Bandwidth**
Designate the speed of the network to which the SHR-4081N/P main body is connected.
Unlimited/2Mbps/1Mbps/600Kbps/300Kbps

! Caution

*If the main frame is connected to a network that uses a high speed LAN, set the bandwidth to 1Mbps or 2Mbps. If the main frame is connected to a network that supports ADSL or lower bandwidth, set the bandwidth below 600Mbps, and set the Record Mode below CIF (STANDARD).
If you set a higher bandwidth or Record Mode in a network that only supports lower bandwidth, the network will be overloaded and the connection to the SmartViewer or video monitoring may not operate properly.*

Note

If the Connection Mode is set to ADSL, the bandwidth of IP settings page will be locked to 300Kbps, and the protocol type of the transfer protocol settings page will be locked to TCP.

- **Admin Password**
The password for the connection between Smart Viewer and the set with the authority of Admin. The password can be as long as 8 digits.
Press "Enter" and the left number keys from 0 to 9 for setup.
- **User Password**
The password for Smart Viewer's access to the set with the authority of general user.
- **IP**
Set up the IP address to connect the SHR-4081N/P main body to the network.
In case of a fixed IP, you must input IP yourself.
In case of a flexible IP or ADSL(PPPoE), the IP allocated from the DHCP server or ADSL company. If you fail to connect DHCP or ADSL, 000.000.000.000 is displayed.
Then, press "OK" to receive IP. If you repeatedly fail to connect DHCP or ADSL, turn the SHR-4081N/P main body power off and turn it on again before you retry connecting.

- **Gateway**
Determines Gateway Address in the SHR-4081N/P main body.
- **Subnet Mask**
Determines Subnet Mask Address in the SHR-4081N/P main body.
- **DNS**
Sets up DNS Address in the main body of SHR-4081N/P. The default of DNS is 168.126.63.1. Generally, you don't have to alter the DNS default but you may be hard to connect to the network sometimes if you use DHCP or ADSL. In this case, call the network manager or ADSL company to set up a new DNS address.
- **ADSL User ID**
If the main body of SHR-4081N/P is connected with the ADSL(PPPoE) network, input User ID subscribed to the ADSL company. You may input User ID with a Virtual key-board as long as 40 digits irrespective of alphabets, numbers, or symbols.
- **Password**
If the main body of SHR-4081N/P is connected to the ADSL(PPPoE) network, input the user password subscribed to the ADSL company. You may input the password with a Virtual keyboard as long as 40 digits irrespective of alphabets, numbers, or symbols.

Caution

Be sure to set up IP/SubnetMask/Gateway/DNS to let Smart Viewer connect with the main body of SHR-4081N/P.

Wrong IP/Gateway/SubnetMask/DNS may prevent Smart Viewer from being connected to the main body of SHR-4081N/P.

Please call the network manager or ADSL company to get each setting value.

Caution

In the ADSL connection mode, SmartViewer does not support Audio replay.

Transfer Protocol Settings

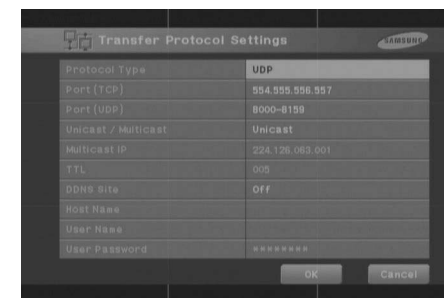

- You may choose the protocol type, either TCP or UDP. ADSL setup in the IP setup page can be made only to TCP.
- Port(TCP) can be selected from 554 to 998, increasing by 4. Once the first digit is chosen, the rest 3 digits will follow the first digit.
- Port(UDP) can be selected from 8000 to 9760, increasing by 160. Once the front port is chosen, the rest ports will change accordingly.
- Unicast/Multicast has the default of Unicast and you may choose Multicast.
- Multicast IP shall be set to Multicast from Multicast/Unicast to be activated and for IP setup. Sets up the D-Class IP address from 224.0.0.0 to 239.255.255.255.
- TTL shall be also set to Multicast from Multicast/Unicast to be activated and to choose a value from 1-255. The default is 5.
- **DDNS Site**
 - You may select the DDNS Site as Off, Samsung DDNS, dyndns.com, no-ip.com, or changeip.com.
 - If you select Off, the IP will not be registered in DDNS.
 - If you select Samsung DDNS, the IP will be registered in the DDNS operated by Samsung.
 - Select MAC Address as the Address Type in the Setup → Site Setup → DVR registration window of the SmartViewer, and enter the MAC Address of DVR (SHR-4081N/P), then you can connect remotely using the Samsung DDNS.
 - dyndns.com, no-ip.com, and changeip.com are free Public DDNS websites that a URL can be allocated by registering a Dynamic IP.
 - Become a member of the desired website, register the URL, and then set up your Host Name, User Name, and User Password.
 - Select URL as the Address Type in the Setup → Site Setup → DVR registration window of SmartViewer, and enter the Host Name (URL) that is allocated by the Public DDNS website, then you can connect remotely using the URL.

Note

If you set up the Public DDNS (dyndns.com, no-ip.com, or changeip.com), it will take approximately 30-60 seconds for the IP address of the Host Name (URL) to be updated in the DNS.

9 Network Setup

Note

If you want to connect IP Router with the main body of SHR-4081N/P, you shall designate a port for SHR-4081N/P in the IP Router setup menu.

The SHR-4081N/P main body uses 4 ports for TCP communication and further 160 UDP ports when the protocol type is set to UDP. In addition, if you want to use the DHCP function backed by IP Router to allocate Dynamic IP to the main body of SHR-4081N/P, you shall designate a port for the IP which SHR-4081N/P has been allocated by the IP Router setup menu.

If you use IP Router, you are recommended to rather determine IP and Port numbers to be allocated to the main body of SHR-4081N/P from the IP Router setup menu, set the connection mode to Static IP for the main body of SHR-4081N/P, and input the determined IP and Port number in IP Router than use the DHCP function.

Please refer to the IP Router User's Manual or call the manufacturer to set up IP Router.

Callback Settings

- Callback delivers a callback message to the IP where SmartViewer is already running when an event corresponding to Alarm, Motion Detection, or Video Loss occurs from the set.



- On/Off : Off is the default and On is optional.
- IP Address : IP setup is available only when On/Off is set to On. Sets up the IP address of a PC where SmartViewer is already running.
- Port(UDP) : You may choose a value from 7900 to 7999, increasing by 1. Sets up the port value of Callback Connection set by SmartViewer.
- Retry : You may choose a value from 1 to 20, increasing by 1.

⚠ Caution

- Though Callback is set to ON, there will be no Callback message unless Alarm, Motion Detection, or Video Loss is set by Event Record.
- Unless you click the Callback button of SmartViewer, SmartViewer does not receive any Callback message.

Port setup for SmartViewer connection.

- The port value shall be the same as the Port(TCP/IP) value of the set to register DVR(Setup → Site Setup) with SmartViewer.
- When you use an IP router, you shall forward the activated port by the current setting value.
 - In case of TCP/IP, set 4 ports(TCP/IP) in the IP router.
 - In case of UDP, set 4 ports(TCP/IP) and 160ports(UDP) in the IP router.

When you set to TCP/IP from the Transfer Protocol Settings page

- The ports set in Port(TCP/IP) shall be used to control SmartViewer connection and transmit Stream.

When you set to UDP from the Transfer Protocol Settings page

- The ports set in Port(TCP/IP) shall be used to control SmartViewer connection and those set in Port(UDP) shall be used to transmit Stream.
- In case of Multicast
 - The MultiCast IP and TTL Setup menu will be activated.
 - MultiCast IP indicates the group address for Multicast transmission(D-Class IP Address : 224.0.0.0 ~239.255.255.255).
 - TTL(Time To Live) indicates how many routers Multicast shall get through.
 - If you are unable to Multicast due to the network(LAN or ADSL) characteristics as both the set and SmartViewer are installed, SmartViewer displays "Not Connected" in the screen. In this case, reset to TCP/IP or UDP(Unicast).
- In case of abnormal screen replay from SmartViewer
 - This may happen when the network bandwidth of the set is smaller than the packet quantity of Transmission Stream. Then, reduce the IP setup bandwidth(to 300Kbps or 600Kbps when installed to the ADSL network).
 - If this does not work, reset the protocol type to TCP/IP.



Chapter 6

PTZ device Control

1 PTZ device Control Mode

- Select a proper PTZ Device Configuration value in MENU to enter PTZ Control Mode.



- Selected in MENU, the symbol() of PTZ is displayed on the channel in the screen.
- If you press the Enter() button among direction keys in front of Split Screen, a blue bar will appear in the monitor screen. Use direction keys to move this bar until you reach the channel with the PTZ symbol and press the PTZ button in front of SHR-4081N/P to enter PTZ device Control Mode. If you succeed in entering PTZ device Control Mode, the PTZ symbol on the monitor screen will turn yellow from white while the PTZ button in front of SHR-4081N/P will turn blue. PTZ device Control Mode supports Pan, Tilt, and Zoom operation.

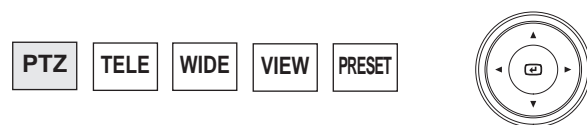

- Other PTZ device Control Modes perform its control in a single screen. Press the channel selection button in the left front to select the channel whose Menu selected PTZ and then press the PTZ button. If you succeed in entering Single Screen PTZ device Control Mode, the PTZ symbol on the screen will turn yellow from white while the PTZ button will turn blue. Single Screen PTZ device Control Mode supports Pan, Tilt, and Zoom operation basically and Preset, Camera Menu, and other functions additionally.

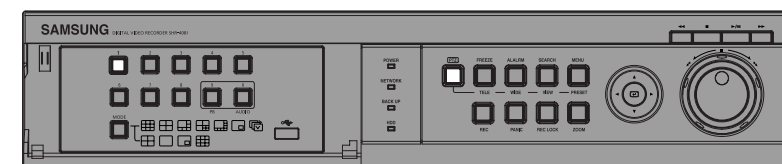
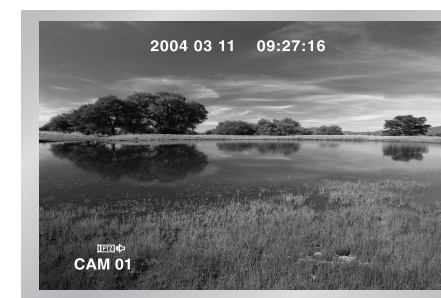

- Press the PTZ button in Live Mode to cancel PTZ device Control Mode. After cancellation, the PTZ symbol on the screen will turn white from yellow while the PTZ button will lose its blue light.

Note

If you select Remote Control Device, you may not control PTZ device with SHR-4081N/P. It's because the PTZ button in front of SHR-4081N/P remains inactivated. Press the PTZ button and the PTZ ban icon() will appear. It's because the RS-485 port setup was done for Remote Control Device. Some functions of PTZ camera may not be used for SHR-4081N/P.

- When using a remote control device (SCC2000), you may perform camera control from the remote control device (limited to Samsung Protocol). (Refer to SCC2000 User's Manual.) The PTZ Mode will be automatically when there is no PTZ control in the DVR for up to 5 minutes. This is to enable the PTZ control from the remote Viewer when there is no PTZ control.

2 Basic Operation of PAN, TILT, & ZOOM

- **PAN**
Press the LEFT or RIGHT button in front SHR-4081N/P in PTZ device Control Mode to control PTZ device horizontally.

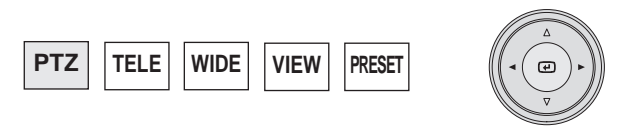

- **TILT**
Press the UP or DOWN button in front SHR-4081N/P in PTZ device Control Mode to control PTZ device vertically.

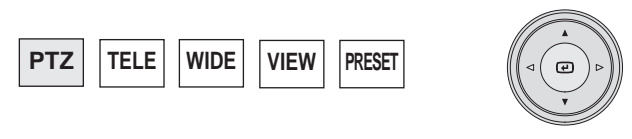

- **ZOOM**
Press the TELE/WIDE button in front SHR-4081N/P in PTZ device Control Mode to zoom in or out PTZ device.

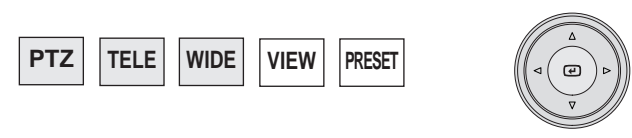

3 PRESET Setup

- Records a certain position of PTZ device.
- Memorizes up to 20 PTZ device positions at the moment.

Note

For AD Protocol PTZ device , this memorizes only 7 positions.

- Press the SET button in front of SHR-4081N/P in Single Screen PTZ device Control Mode to set up Preset.



- After PRESET setup, press ENTER.

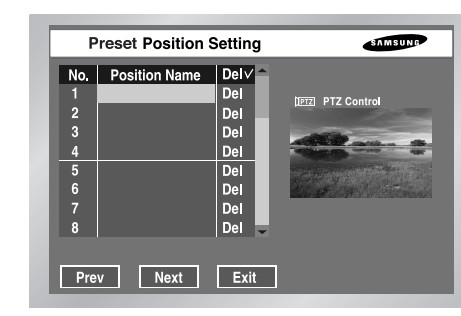

4 Camera Menu Setup

- Move the cursor right and press ENTER in PTZ Control Mode first. Then, press Enter to run P/T/Z/ Motion Mode in the PIP screen and press Enter again to cancel P/T/Z/ Motion Mode.
- Press Enter at the Position Name position to see Virtual Keyboard. Type Position Name and press OK to save Position and Position Name.

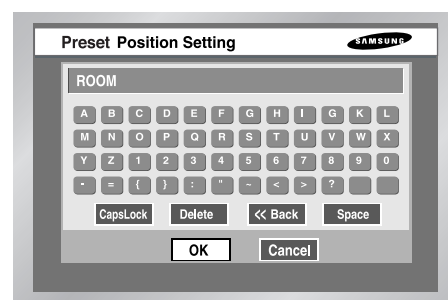

- Press Del to delete both Position and Position Name with the number.
- Press Del ✓ on the top to delete all Positions and Position Names in memory.

- Camera Menu is a menu supplied by PTZ device itself. This Menu sets up several conditions of PTZ device.

Note

Either Pan. or Samsung Protocol Camera only is authorized for Camera Menu setup.

- Press the SET button in front of SHR-4081N/P in Single Screen PTZ device Control Mode to select Camera Menu.

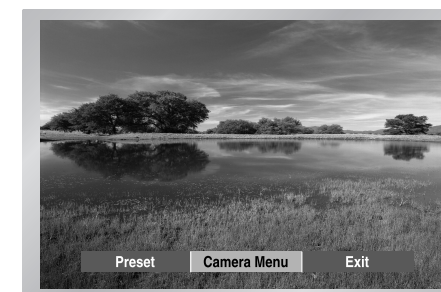

- Press the SET button in front of SHR-4081N/P to return to the upper menu from SET button Camera Menu.

5 Preset View

- Preset setup allows your movement to a certain saved position of PTZ device.
- Press the VIEW button in front of SHR-4081N/P in Single Screen PTZ device Control Mode to select Preset.



(For example, Samsung Protocol)

- Control the cursor until it reaches a Preset position number that you want to move to and you can check the right movement through in PIP Screen on your right.

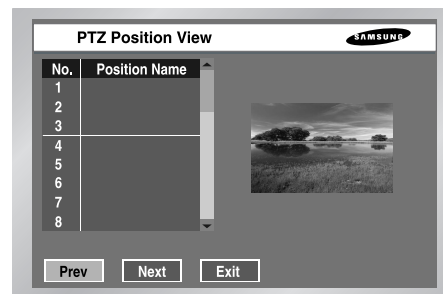

6 Other View

- Press the VIEW button in front of SHR-4081N/P in Single Screen PTZ device Control Mode to supply PTZ device. This is a very special function.

Note

Samsung, Pan., Pel.-P, or Pel.-D Protocol PTZ device supplies this function.

Samsung : Auto Pan / Scan / Pattern

Pan. : Auto Pan / Sequence / Sort

Pel.(P,D) : Auto Scan / Frame Scan / Pattern

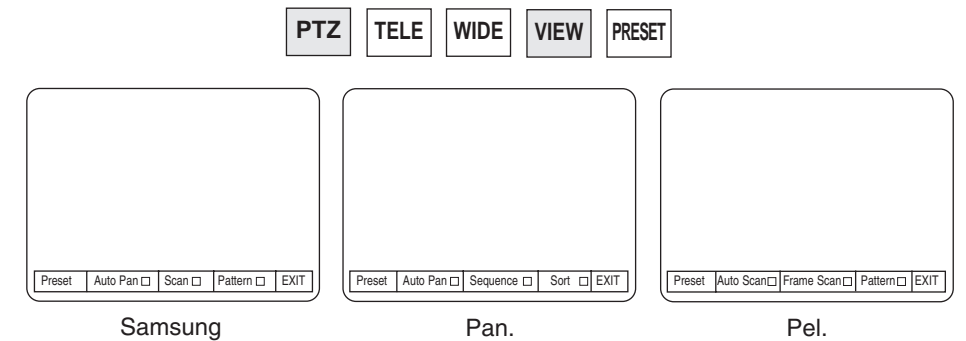

- After you select a function, press Enter. Then the function will be checked and start running.
- If you select other function while this function is in action, the previous function will be unchecked and the current function will be checked.

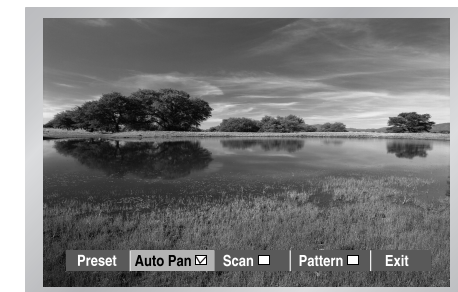

(For example, Samsung Protocol)

- If you put P/T/Z/ in operation or enter Preset Setup or Camera Menu Setup Menu while this function is in action, the function in action will be suspended and unchecked.
- Restart of SHR-4081N/P System in action has no effect. The function continues its duty and remains checked.



Chapter 7

Recording

1 PANIC (Emergency Recording)

- Pressing the button records all the images input so far. Emergency Record has the characteristics of CIF size, Very High resolution, and 15ips(NTSC)/12.5ips(PAL). During PANIC Recording, LED lights on and a recording icon appears on the screen. During recording in HDD, HDD LED in front blinks.
- During PANIC Recording, you may stop PANIC Recording by pressing the button then LED lights out.

Warning

If you carry out the functions necessary to stop recording(Time Change, File Delete, HDD Connect/Disconnect, etc.), recording will be paused.

2 REC (Normal Recording)

- Pressing REC the button starts recording as set in Record Mode of MENU. Then, REC LED lights on and a recording icon appears on the screen. During recording in HDD, HDD LED in front blinks.
- During REC Recording, you may stop REC Recording by pressing the REC button then REC LED lights out.
- If you press the REC LOCK button during REC Recording, REC LOCK LED will light on and the REC button will be locked. Cancel REC LOCK first and press the REC button to cancel REC.

Warning

If you carry out the functions necessary to stop recording(Time Change, File Delete, HDD Connect/Disconnect, etc.), recording will be paused.

3 Record Schedule

- While “Continuous Recording” or “Both” is selected for Record Schedule in MENU, Timer Recording automatically starts. Otherwise, Timer Recording remains inactivated. During Timer Recording, Recording Icon appear on the screen. During recording in HDD, HDD LED in front blinks.

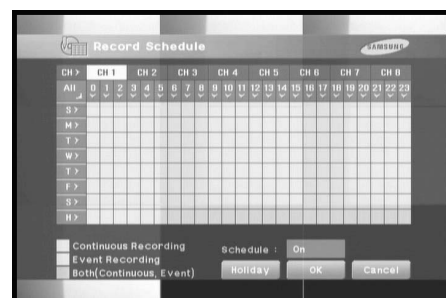

- During the event recording, the auto recording is operated when the event occurs. In this case, the event recording is saved according to the related channel setup within the event recording items(Resolution, Frame, Pre-alarm, Post-alarm) of recording menu.

Note

Even in case of an event, Event Recording will not start unless Event Recording or Both is selected in Record Schedule.

Warning

If you carry out the functions necessary to stop recording(Time Change, File Delete, HDD Connect/Disconnect, etc.), recording will be paused.

4 Event Recording

- Alarm Detection Setup
Sensor State in Event Record Alarm of MENU shall be set to N.O (Normal Open) or N.C (Normal Close)
- Motion Detection Setup
M.D State in Event Record Motion Detection of MENU shall be set to On.
- Video Loss Detection
Image Loss State in Event Record Image Loss of MENU shall be set to On.
- Event Record Mode Setup
When Event occurs, it designates recording type. In particular, depending on Pre-Event Off or Post-Event Off, Pre-Event or Post-Event Recording is disabled respectively.

Warning

If you carry out the functions necessary to stop recording(Time Change, File Delete, HDD Connect/Disconnect, etc.), recording will be paused.



Chapter 8

Search & Play

Before Use



- Pressing the SEARCH button shows Search Menu on the screen as seen above.
- CALENDAR uses a calendar to search video files at the preset time.
- Event Search searches video files recorded by Event.
- Date/Time inputs a day and time on which the system searches video files.
- Go To First searches video files from the oldest one.
- Go To Last searches video files from the latest one.
- Backup Search searches backed-up video files.
 - If you select the external HDD, you are able to search IEEE1394 HDD and USB HDD.
 - If you select the external USB device, you are able to search Memory Device and USD CD/DVD.

Note

During Backup Pressing the Search button will have no effect to let you enter the Search mode. (⏪)

1 Calendar Search



- Be sure to designate both the channel and the date first. Then press [OK] button to initiate search.
- Uses a calendar to search video files at the preset time. Four channels as a maximum are in the range of search.
- Press [Enter] ◀, and ▶ to choose 4 channels as a maximum and the date column with recorded video image will turn blue.
- Use ▼ to move to the row where you are able to choose a year/month and press [Enter] ◀, and ▶ to select a year/month as you wish.
- Press [Enter] to select a date with a recorded image and the box on the right of the number indicating the date will appear after checked.
- Press ▼ to move to Time Bar and press ◀, and ▶ to move to the time that you want and press [Enter] to select the time.
- Press [OK] to start search and press [Cancel] to move to the previous menu.
- The Time bar appears every 30 minutes.

2 Event Search

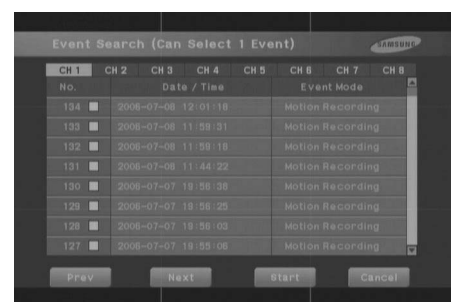

- Searches Normal Recording, Panic Recording, Sched.(Schedule) Recording, Alarm Recording, Motion Recording, and Image Loss Recording by the time.
- You shall select a channel to search to see the Event information of the channel.
- On the basis of the Event information for each channel, the system searches the video file for the event. Only one channel is allowed for video search.
- Press [Enter] ◀, and ▶ to select a channel and the event list for the selected channel only will be displayed.
- After channel selection, press ▲, ▼, and [Enter] to select a channel from the event list. The box on the left of the selected event number will be checked.
- Press ▼ to move to [Start] and press [Enter] to start search and move to [Cancel] and press [Enter] to cancel search. Press [Next] followed by [Enter] to see the event list in the next screen and press [Prev] followed by [Enter] to see the event list in the previous screen.

3 Date/Time Search

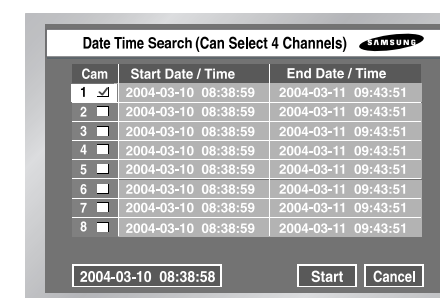

- Use the Date/Time information to search video files at the time as you desire. Up to 4 channels can be searched at once.
- Press ▲, ▼, and [Enter] to select a channel and the box on the right of the channel will be checked.
- After channel selection, press ▼ to move to the row where you can choose the search time. To change the search time, press [Enter]. The search time can be controlled by years/months/days/hours/minutes/seconds and each value can be changed by pressing ▲, ▼ For your convenience, keep pressing the button to change the value continuously.
- Press ▼ to move to [Start] and enter [Enter] to initiate search and move to [Cancel] and press [Enter] to cancel search.
- The time information in the bottom left corner, 2004-03-10 08:38:58 indicates the time when play starts.

4 Go to First Search

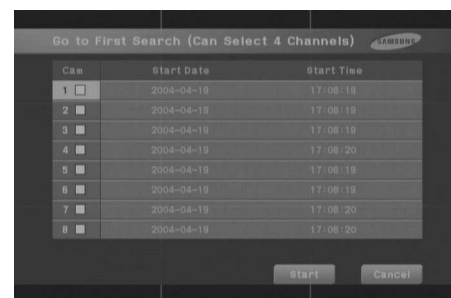

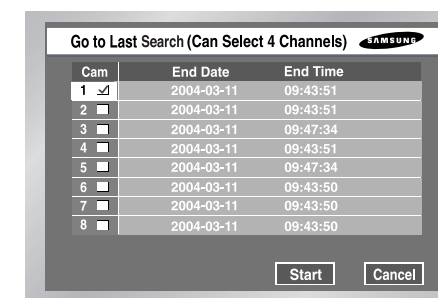

- Searches the oldest one among recorded video files. Up to 4 channels can be searched at once.
- ▲, ▼, Press [Enter] to select a channel and the box on the right of the channel will be checked.
- Press [Start] to start searching and press [Cancel] to return to the previous menu.

5 Go to Last Search



- Searches the latest one among recorded video files. Up to 4 channels can be searched at once.
- ▲, ▼, Press [Enter] to select a channel and the box on the right of the channel will be checked.
- Press [Start] to start searching and press [Cancel] to return to the previous menu.
- Recent Search is used to search the image at the moment that you start searching.



6 Play

- Press the PLAY/PAUSE button() to play the data recorded in HDD.
- This chooses out a channel with the oldest data among recorded channels and plays the data from the first part of the channel. If you used the SEARCH button for play just before, the system would remember the information of the played channel until you click the PLAY/PAUSE button() again, then the system plays the previous channel.

If you press the PLAY/PAUSE button(), the Search Menu will appear as far as you never tried Play.

Note

- Pressing the PLAY button() does not affect play as far as the user stays in MENU. Be sure to escape from MENU to start play.

- Press the STOP button() to stop play. If you press the Playback/PAUSE button(), recording will resume from the point where the previous recording stops. When the data position reaches the end of HDD during play, play will be paused.





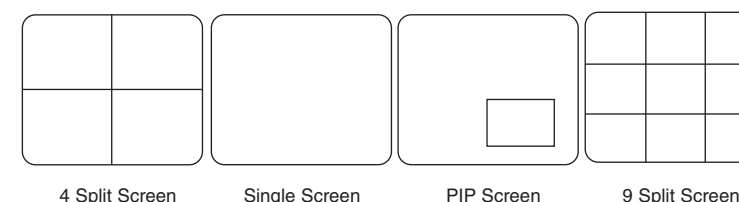

- Play Screen Mode Definition



PIP Screen Single Screen 4 Split Screen 9 Split Screen Whenever you press [Mode], the Play screen becomes 4Split, Single, PIP, 9Split in turn. If you select only one channel from Search, the 4 Split screen will not appear.

- ① 4 Split Screen : If you select more than one channel from Search, the 4 Split screen will appear.
- ② Single Screen : This screen appears when you choose only one channel from Search. If you press [Enter] in the 4 Split screen, a blue bar will appear. Place the bar in the position that you wish to and press [Mode], the selected channel will become the Single screen. Press the [ZOOM] button to enlarge the selected area twice.(Refer to 4-6, Zoom Function.)
- ③ PIP Screen : Press [Mode] during Single screen play and it will be displayed in the PIP screen.(The larger screen displays the channel in play and the smaller screen in the bottom right corner displays Live CH in the form of PIP.) Use ▲, ▼ to move the smaller PIP screen(Live CH) vertically. Press [Enter] and a blue bar will appear in Live CH. Press the CH button and the Live screen will become the selected channel.
- ④ 9 Split Screen : Press [Mode] in the PIP screen and the 9 Split screen(Live 8CH + Play 1CH) will appear. You may set the Play screen position to "Center" or "Bottom Right" by pressing Menu → Monitoring Menu → PB CH Position.(9 Split only) Press the [Enter] button and a blue bar will appear in Live CH. Press the CH button that you wish and the Live screen will be converted into the selected channel. Press [Mode] button to move to the 16 split screen again.

- **Play at Faster Speed**
If you press the LEFT or RIGHT button( / ) or use the Shuttle during play, you will be able to see the screen at the x2, x4, x8, x16, x32, and x64 speed either forwardly or reversely.
- **Viewing Still Screen**
If you press the LEFT or RIGHT button( / ) or use the Jog shuttle with the system paused, you will be able to see still screens forwardly or reversely. During reverse search, the interval between cuts varies depending on the recording specification.
- **Audio On/Off**
If you press the "16" button in other screen than 4 Split Screen(i.e. Single Screen, PIP Screen, and 9 Split Screen), you will be able to turn Audio of the channel in play on or off. In 4 Split Screen, Audio is not activated.



Chapter 9

Backup and Backup Search

1 Backup

1. IEEE1394 HDD and USB HDD

1.1 Backup Start

Before backup, HDD(IEEE1394, USB) shall be connected for such purposes.

- ① Choose either IEEE1394 HDD and USB HDD as a backup device.
- ② Select a backup channel and change the time when back starts and ends.
- ③ The backup video file size shall be maintained below the free space of the external HDD.
- ④ Press "OK" button to back up the video data of the selected channel at the designated time in the external HDD.

Note

*Pressing "Cancel" does not cancel nor stop backup but move to the upper menu while back continues.
Pressing "Stop" stops backup.*

1.2 Backup Stop

- ① Select Stop in the backup process to stop backup.
- ② Then, the Backup menu will be displayed in the screen.
- ③ If you change the system time or terminate the system, the current backup process will be paused.

1.3 Backup Play

- ① Press the SEARCH button in front of SHR-4081N/P and press the Backup Search menu to play backup.
- ② To search backup, select the device.
- ③ Select a channel and time in the Backup Search menu and press the time for play.

Note

*Backup can not be played during backup.
Refer to the User's Manual 8-7, Backup Search.*

2. CD/DVD and USB Memory

1.1 Backup Start

- ① Choose USB Memory or USB CD/DVD as a backup device.
- ② Select a backup channel and change the time when back starts and ends.
- ③ The backup video file size shall be maintained below the free space of USB Memory and USB CD/DVD.
- ④ Press "OK" to back up the video data of the selected channel at the designated time in USB Memory and USB CD/DVD.

Note

1. Pressing "Cancel" Button does not cancel nor stop backup but move to the upper menu while backup continues.
2. Pressing "Stop" stops backup.
3. Both USB CD/DVDs are not allowed in the USB connection port in front of and behind SHR-4081N/P.
4. Both Memory Devices are not allowed in the USB connection port in front of and behind SHR-4081N/P.

1.2 Backup Stop

- ① Select Stop in the backup process to stop backup.
- ② Then, the Backup menu will be displayed in the screen.
- ③ If you change the system time or terminate the system, the current backup process will be paused.

1.3 Backup Play

- ① Press the SEARCH button in front of SHR-4081N/P and press the Backup Search menu to play backup.
- ② To search backup, select the device.
- ③ Select a channel and time in the Backup Search menu and press the time for play.

Note

*Backup can not be played during backup.
Refer to the User's Manual 8-7, Backup Search.*

2 Backup Search

⚠ Caution

1. During backup, you shall not separate the backup device from SHR-4081N/P.
2. During backup search, you shall not separate the backup device from SHR-4081N/P.
3. Be sure to detach the device before you separate the backup device from SHR-4081N/P (refer to User's Manual 5-8, HDD and External Device Setup.).
4. In case of backup by using a USB memory, be sure to format with FAT32 and use a USB memory device with one partition. In addition delete the USB memory at SHR-4081N/P for safe backup (refer to 5-7, System Information and Setup.).
5. When you connect the backup device to SHR-4081N/P, it takes some time for SHR-4081N/P to recognize the backup device. Consequently, connecting the backup device to SHR-4081N/P and executing backup may not result in the connection of the device. In such a case, please retry shortly later.

1. Backup search menu

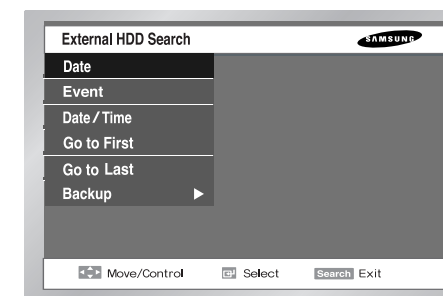

1-1. External HDD Search

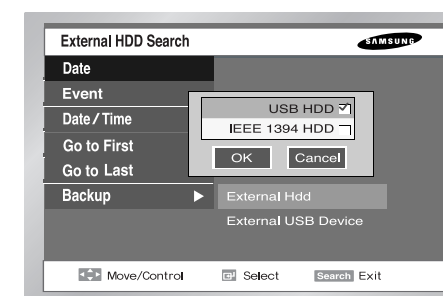

- If you select an external HDD, you may search the data by using Date, Event, Origin, or Late. Refer to p8.2~p8.5 for this purpose.

1-2. USB Device Search

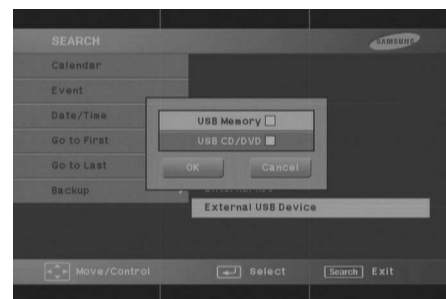

- Select an external USB device to search a date.

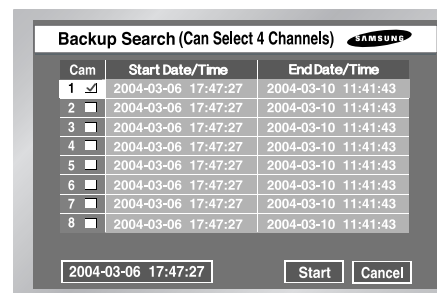

- Use the weekday/time information in the backup image to search images contained in as many as 4 channels.
- Click ▲, ▼, [Enter] to select a channel and the box on the right of CH No. shall be checked.
- After channel selection, click the ▼ button to move to the time search line. Click [Enter] to change the search time. The search time may be changed by Year/Month/Day/Hour/Minute/Second by clicking ▲ or ▼. For your convenience, just keep pressing a button and the value will continue to change.
- Click [Start] to start searching and [Cancel] to return to the previous menu.
- The time information in the bottom left corner, 2004-03-06 17:47:27 indicates when to start replay.



Chapter 10

Smart Viewer

1 Introduction

Smart Viewer is a program that a general PC user is able to install SHR-4081N/P to his PC to monitor the search video and audio data through Network without going to the site where SHR-4081N/P is installed by himself.

2 Feature

- Thanks to the transmission of video data compressed by the MPEG-4 Video Compression method, this plays video images of good quality.
- Thanks to the G.726 Voice Compression method, this supplies voice data of good quality. Use of armored MIC improves the quality of remote voice.
- Thanks to the transmission of video/audio stream through RTP(Real-Time Transport Protocol), real-time video play capacity is excellent and multi-users' simultaneous connection does not affect the transmission speed in whole abruptly.
- Command & Control by RTSP(Real-Time Streaming Protocol) enables safety control through Network.
- Supports various transmission protocols (TCP/IP, UDP(Unicast, Multicast)).
- Connection is open to you at any time to monitor video and audio data by inputting IP Address only.
- You can not only perform real-time recording (*.dvr format) whereas necessary during monitoring but also convert recorded video files (*.dvr format) into frame unit images((JPEG format).
- One DVR set allows 3 Smart Viewer users(or 6 with Multicast) at the same time.
- With a Smart Viewer, you are allowed to connect to as many as 9 SHR-4081N/P to monitor them simultaneously.
- Smart Viewer is optimized in the resolution of 1024X768

3 PC Specification(Recommendation)

- OS : Win98SE, WinMe, Win2000, WinXP
- Recommendation : CPU Pentium3 1GHz or higher
RAM 256 Mb or higher
VGA RAM 32Mb or higher
DirectX 8.1 or higher

Note

*Depending on Recording Rate, Video Size, and user's PC specification set to SHR-4081N/P, the number of Smart Viewer play frame varies.
For the detailed specification, refer to Appendix 5.*

4 Smart Viewer Installation

Smart Viewer Installation

- Put a Smart Viewer Program CD in and open the "Smart Viewer" folder in CD.

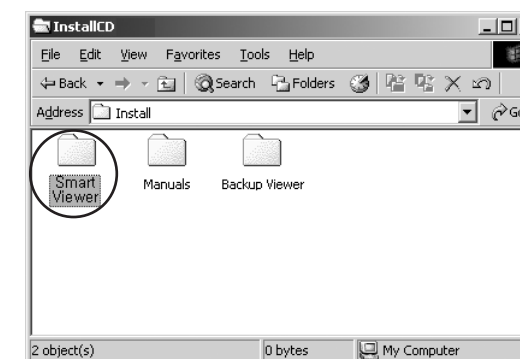

- Run the "Setup.exe" file.

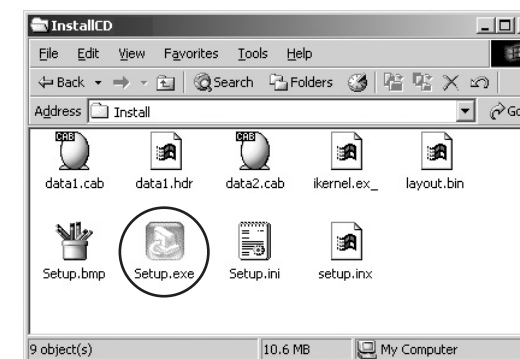

- Click the "Next" button.



- If you agree with Smart Viewer License, click "Yes".

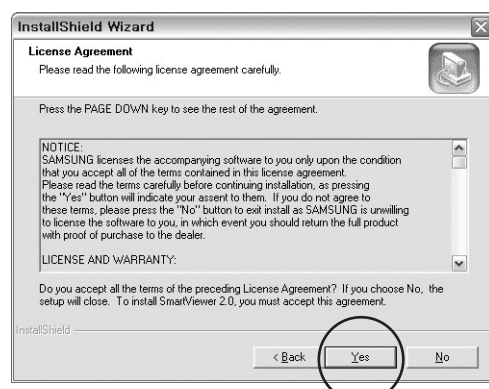

- Designate a folder to install Smart Viewer in it and click "Next".



- The system proceeds with setup file installation and system setup.

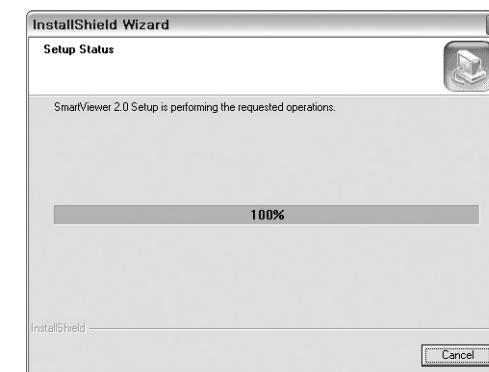

- Installation is complete. Press "Finish" to terminate installation.



5 Smart Viewer Program Execution

- Double-click the Smart Viewer icon in the background screen to run the program.



6 Smart Viewer Initial Screen

- Screen Description

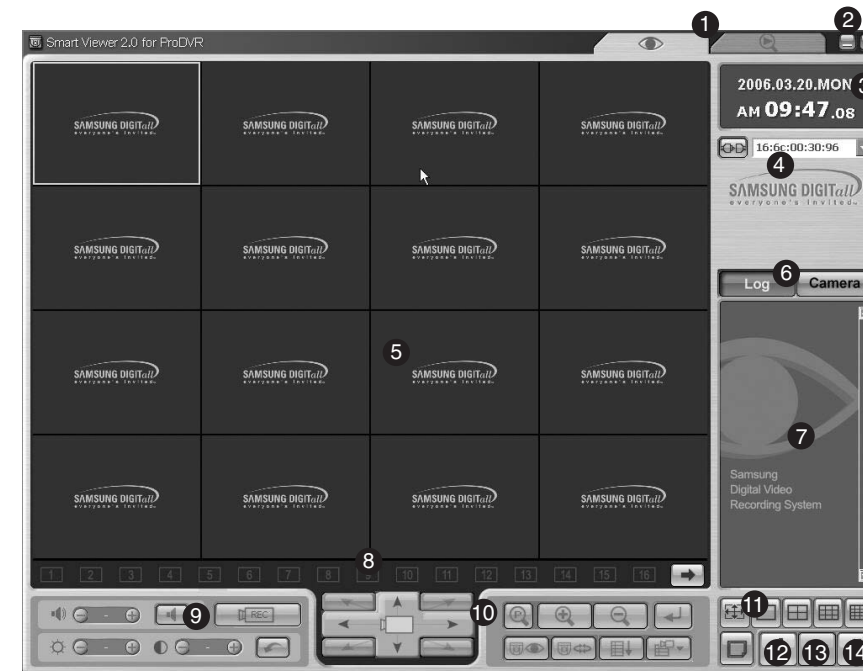

- ① Pressing this button enters Search Mode in which you can search and play the video data recorded both in Monitoring Mode for real-time video data monitoring and in SHR-4081N/P.
- ② This button terminates or minimizes the program.
- ③ It displays the current date, day, and time.
- ④ This button is used for the connection with the preset DVR(SHR-4081N/P) or site.
- ⑤ This screen shows the monitoring video image.
- ⑥ These buttons are used to select the window to display event messages and came connection condition.
- ⑦ This window displays the event message from SHR-4081N/P real-time.
- ⑧ These buttons display the status of channel being played in the present .
- ⑨ This button adjusts Audio Volume and Video Brightness/Contrast or records video data.
- ⑩ This button is used for PTZ related functions.
- ⑪ This button is used for screen split and Sequence Mode.
- ⑫ This button is used for Callback connection.
- ⑬ This button is used for the Favorite function to contact a site.
- ⑭ This button puts up the Setup Mode window to change Smart Viewer or SHR-4081N/P setup. (Refer to 10-30. Setup Mode.)

7 Monitoring Mode

- DVR(SHR-4081N/P)/SITE Connection
 - Select the name of DVR(SHR-4081N/P) or site for connection and click the connection button.

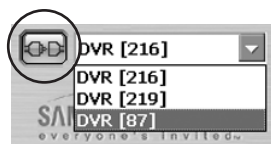

Note

You can determine the name, IP, and password of DVR(SHR-4081N/P) for connection in Setup Mode. Also, setup of a site which permits simultaneous connection to multi-DVRs(SHR-4081N/P) is available in Setup Mode. When you connect to the SITE, you may connect to a maximum number of 16 DVRs (SHR-4081N/P) simultaneously.

◆ Connection Failure Cases

1. Password Certification Failure



- In case of discord between the Network password set to SHR-4081N/P and the connection password set to Smart Viewer, a window pops up to induce retry of password input.

2. Admin User Connection Failure



- Where SHR-4081N/P that you wish to connect to has been already occupied by other user in an Admin. Capacity, you are authorized with access to SHR-4081N/P concerned in a User capacity.

Note

No more than 3 users, one Admin, authorized user and 2 User authorized users are allowed to access SHR-4081N/P simultaneously. One SHR-4081N/P allows as many as 3 users, 1 Admin and 2 Users for simultaneous connection(or as many as 6 users including 5 Users for Multicast).

! Caution

Only 3 users can be connected to the SHR-4081N/P(6 Users in Multicast).

- Monitoring Mode Connection Screen



! Caution

If you alter "Resolution" or "Color Quality" from the setup tab of [Display Registration Information] while Smart Viewer is running, Smart Viewer will fall into an unexpected condition. You shall terminate Smart Viewer first to recover the condition.

- Mode Conversion Button



- This button changes Monitoring Mode or Search Mode.

- Time Information

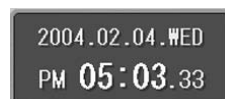

- As soon as you are Connected to SHR-4081N/P, the date, weekday, and time of the set to which the selected channel is connected.
- If SHR-4081N/P is not connected, the present date, weekday, and time of the user's PC are displayed.

- Connection Information



- As soon as you are connected to SHR-4081N/P, the connection button will display connection status.
- If you click the connection button here, connection will be cancelled. 



- Play Screen OSD Information



- ① Channel no., camera name, and video size will be displayed.
Video Size (C) CIF / (N) Normal / (L) Large
- ② The Video data of the current channel are recorded in your PC with REC mark displayed.
- ③ Audio ON/OFF Button is marked.
- ④ Displays the name, IP address, and play time of the current SHR-4081N/P.
- ⑤ The current channel alarm status is displayed.
- ⑥ Possibility of the current channel PTZ controllability is displayed.

Note

- ③ Clicking the speaker icon turns Audio of a channel on or off.

 : Audio OFF  : Audio ON

If you turn Audio of a SHR-4081N/P channel off, Disable will be displayed.

 : Audio Disabled

* For the channel with Audio turned on now, use the following Audio relate button to control Audio volume and set up MUTE.

* Once TCP/IP is selected, Audio will be turned off.

Note

- ⑤ Where Alarm or Motion Detection occurs at a channel of SHR-4081N/P with Alarm or Motion Detection established, an icon pops up on the screen real-time.

 : Motion Detection  : Alarm Event

Note

- ⑥ If you connect and set up PTZ device in SHR-4081N/P, PTZ controllability of the channel will be displayed.

* Select a channel capable of PTZ and use the PTZ related buttons at the bottom to control PTZ. (Refer to the description of PTZ Related Button.)

- Event Log Display Window



- Click the Log button to activate the Log Display window.
- Displays the event(alarm, user connection, and setup change) occurring at SHR-4081N/P real time.

Note

[Event Message]

- ▶ **Connecting..** : Trying to connect to SHR-4081N/P.
- ▶ **Connected..** : Succeeded connecting to SHR-4081N/P.
- ▶ **Connection Failed** : Failed in connecting to SHR-4081N/P.
- ▶ **Disconnected..** : Finished connecting to SHR-4081N/P.
- ▶ **Setup(Remote)** : SHR-4081N/P at DVR Setup of Viewer changed.
- ▶ **Setup Start / End (Local)** : Start/Finish the Menu screen at SHR-4081N/P.
- ▶ **Video Loss CH[N]** : Video Loss at the N channel of SHR-4081N/P encountered.
- ▶ **Time Change** : Date/Time of SHR-4081N/P changed.
- ▶ **Load Factory Default** : SHR-4081N/P System initialized.
- ▶ **Network Change** : SHR-4081N/P Network setup changed.
- ▶ **System Shutdown** : SHR-4081N/P System terminated.
- ▶ **Hdd Format** : SHR-4081N/P HDD initialized.
- ▶ **Disk Full** : No more space in SHR-4081N/P HDD.
- ▶ **Power Failure Recovery** : SHR-4081N/P resumed after power failure.
- ▶ **Backup Start/End/Fail/Stop** : Backup at SHR-4081N/P started/finished/failed/stopped.
- ▶ **Network Traffic Busy** : When the data is not transferred smoothly
- ▶ **Access Denied(Limit Over)** : When user can be connected are exceeded

⚠ Caution

When Time Change, Load Factory Default, Network Change, System Shutdown, or Hdd Format event occurs, Smart Viewer terminates automatically.

- Camera Connecting Indication Window

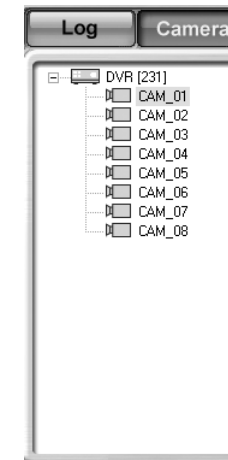

- List displays the connection condition of DVR and CAMERA.

Note

[DVR Icon Mark]

- ▶ **If you succeed in SHR-4081N/P connection, the icon will be turned yellow, otherwise black.**

[DVR Icon Mark]

- ▶ **During monitoring by connecting with CAMERA, it will turn yellow.**
- ▶ **Depending on the availability of connection, it turns blue(Able) or black(Disable).**

● Screen Split Selection Button



- Full Screen / Single / Quad / Nine-Split Mode
- You may change the Split Mode of the screen under monitoring.

● Sequence Mode Button



- Changes the channel to be played at the preset interval.
- The sequence time interval setup follows the procedure of Setup Mode → Viewer Setup.
- In Single Mode : 1 → 2 → 3 → 4 → 5 → 6 → 7 → 8 → 1 (CH)
- In Quad Mode : 1,2,3,4 → 5,6,7,8 → 1,2,3,4 (CH)
- In Nine-Split Mode : 1,2,3,4,5,6,7,8 → 1,2,3,4,5,6,7,8,9 (CH)

Note

If you connected with multi-DVRs(SHR-4081N/P) through a site, Sequence will operate as follows.

- In Single Mode : DVR1:1CH →...→ DVR1:8CH → DVR2:1CH →...→ DVR1:1CH
- In Quad Mode : DVR1:1,2,3,4CH →...→ DVR1:1,2,3,4CH → ...
- In Nine-Split Mode : DVR1:1,2,3,4,5,6,7,8CH →DVR2:1,2,3,4,5,6,7,8CH →...

● Monitoring Screen Condition Information / Selection Button

- Displays the Split or Monitoring condition of the screen in play.



: During monitoring in Nine-split Mode



: During monitoring in Quad Mode



: During monitoring in Single Mode

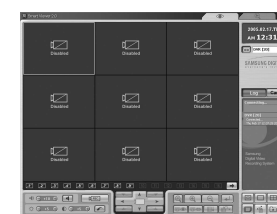

: Camera Off

Note

The figure in a screen icon indicates the screen position in SmartViewer.

- : The orange icon indicates the current channel is connected to a camera.
- : The gray icon indicates the channel is connected to a camera but not displayed on the screen.
- : The black icon with a diagonal line indicates no camera is connected.

● NEXT Button



- Click NEXT(Mouse Left Button) to see the channel next to the current monitoring channel.
- In Single Mode : 1 → 2 → 3 → 4 → 5 → 6 → 7 → 8 → 9 → 10 → 11 → 12 → 13 → 14 → 15 → 16 → 1 (CH)
- In Quad Mode : 1,2,3,4 → 5,6,7,8 → 9,10,11,12 → 13,14,15,16 → 1,2,3,4 (CH)
- In Nine-Split Mode : 1,2,3,4,5,6,7,8,9 → 10,11,12,13,14,15,16 → 1,2,3,4,5,6,7,8,9 (CH)

Note

If you connected with multi-DVRs(SHR-4081N/P) through a site, Sequence will operate as follows.

- In Single Mode : DVR1:1CH →...→ DVR1:16CH → DVR2:1CH →...→ DVR1:1CH
- In Quad Mode : DVR1:1,2,3,4CH →...→ DVR2:13,14,15,16CH → DVR1:1,2,3,4CH → ...
- In Nine-Split Mode : DVR1:1,2,3,4,5,6,7,8, 9CH → DVR1:10,11,12,13,14,15,16CH → DVR2:1,2,3,4,5,6,7,8,9CH →...

● CALLBACK Button



- Click the CALLBACK button to activate the CALLBACK window and it is ready to receive a message.
- Upon receiving a message, Smart Viewer will automatically try to connect the DVR.
- A message is received at the time of Video Loss, Alarm, and Motion Detection.Mode.
- You can select if the alarm is set to ON when it receives an event message.



● FAVORITE Button



- Click the FAVORITE button to activate the FAVORITE window.



- a** Click the current FAVORITE to display all the cameras recorded in the setting.
- b** You may delete all the selected FAVORITE settings or all the FAVORITE settings.
- c** You can select a new FAVORITE number and name.
- d** Alters FAVORITE at the selected intervals.

Note

- *The FAVORITE button can be activated for use only when the site is contacted.*
- *The FAVORITE setup information will remain in the Config file even after the site contact is cancelled.*
- *If you revise the DVR list composing the site in the Setup menu, the FAVORITE value will be initialized.*

- Video Recording Button



- If you select a channel in play and click the REC button, the image will be saved in a file format with the extension of *.dvr in a designated folder of your PC.
- The name of the directory in which an image will be saved, the file name, and the image save length shall be set up by Setup Mode → Viewer Setup.
- The length of an image to be saved ranges from one minute to 10 minutes.
- The saved image can be played in Local Mode of Search Mode.
- Click the button again to stop recording. However, manual suspension is prohibited for 10 seconds after recording started.

- Audio Volume Control Button



- You may control Audio volume of the channel in play or set up Mute for it.
- You can increase or decrease Audio volume by 1 between 0 and +10.

- Video Brightness/Contrast Control Button



- Select the channel in play and use the control button(+,-) to adjust brightness or contrast of the image.
- The default is set to +5.
- You can increase or decrease brightness or contrast by 1 between 0 and +10.
-  Press the Button to recover the default.

Note

The adjusted Audio volume, brightness, and contrast values will be saved in your PC and remain unchanged even if you terminate Smart Viewer and restart it.

** OS of Windows 98 or ME do not support this Brightness/Contrast function.*

- PTZ device Control Buttons



- Select a channel connected to PTZ device to control PTZ related functions.
- PAN Left / Right
- TILT Up / Down
- Diagonal Control
- The channel under PTZ control will be displayed in the center of the button.



①② ZOOM IN / OUT

③ POWER ZOOM : Click P to activate POWER ZOOM.

- POWER ZOOM is a function to enlarge or reduce a video screen by touching the screen itself.
- After POWER ZOOM is dominant, ZOOM IN / OUT will zoom in or out the video screen.
- POWER ZOOM Operation Procedure : Click POWER ZOOM → Select ZOOM IN or OUT → Click ZOOM IN or OUT in the video screen → ZOOM IN / OUT will be activated in the clicked part.

Note

The PAN / TILT / ZOOM function is supplied to all camera.

But, POWER ZOOM is supported only by Samsung Smart Dome Camera, with TILT below 45°.



① PRESET

- If you press the PRESET button, a window for PRESET setup pops up.



a If you click the current PRESET number and name, the camera will move accordingly.

b You can delete the selected or all PRESET setup values.

c You can set up a new PRESET number and name.

Note

① The PRESET function is supplied to all camera.

You are allowed to set up no more than 20 PRESET items.
But, the AD Protocol camera supports up to 7 PRESET items.

- ② AUTOPAN : The camera executes this function, reciprocating between Start and End.
- ③ SCAN : The camera executes this function, circulating the PRESET setup positions.
- ④ PATTERN : The camera executes this function, following user defined route.

Note

The name of ②, ③, and ④ functions varies depending on the camera and some cameras does not support any of those functions.

- The Samsung camera supports all the functions and names.
- The Panasonic camera supports all the functions, but with different names.
 - ② SEQUENCE ③ AUTOPAN ④ SORT
- The PELCO camera supports all the functions, but with different names.
 - ② FRAME SCAN ③ AUTO SCAN ④ PATTERN
- Other cameras do not support the ②AUTOPAN, ③SCAN, and ④PATTERN functions.

- Self Menu Setup of PTZ device



① You may set up the Function Menu in PTZ device.



- ① This is a Menu screen supplied by the camera itself, seen from Viewer.
- ② Use the ↑/↓/←/→ button for the movement between menus.
- ③ This is a button for the role of Enter.

Note

The Camera Menu Setup function is supported by Samsung and Panasonic.

Caution

As far as SHR-4081N/P uses the PTZ device control related functions, Smart Viewer can not control PTZ device.
The PTZ device control related functions are authorized with the user with Admin authority.

8 Search Mode

- The initial screen of search mode
 - The search mode is divided into the remote mode to search and play the SHR-4081N/P video and the local mode to play *.dvr file saved in the directory designated by your PC.

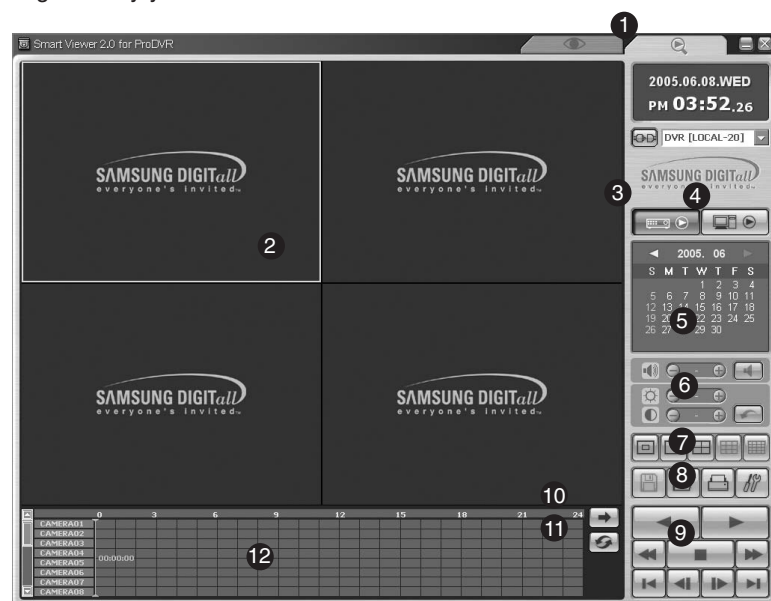

- To change to the search mode for the remote control of video recorded in SHR-4081N/P.
- To show the playback video.
- To change to the remote mode for the transmission of video recorded in SHR-4081N/P through network.
- To change to the local mode for the playback of *.dvr files recorded in your PC.
- Calendar window to select "Year/Month/Day" for search.
- To control the audio volume and video brightness/contrast.
- To change the screen split.
- Button for the Record / Convert File / Print / Setup functions.
- To control the playback of searched video.
- To display the next channel in order.
- To change the channel and DVR or renew the calendar window and Time Line.
- Timeline to display the time information of search date recorded in SHR-4081N/P.

Note

- When connecting to the site, select a DVR to search in the camera connection list.
- When connecting as a user, you are denied to access the search mode.

- DVR(SHR-4081N/P) Selection/Change by contacting SITE
 - Same as "DVR(SHR-4081N/P)/SITE Connection" of the monitoring mode.

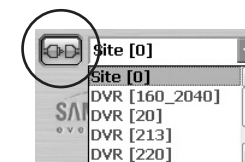

- DVR(SHR-4081N/P) Selection/Change by contacting SITE
 - Select SHR-4081N/P from the Contact list.
 - SHR-4081N/P turns black if contacted with the ADMIN authority and turns gray if contacted with the USER authority.
 - Without the ADMIN authority, search is not accessible.



- Remote Mode
 - This mode transfers the video data recorded in SHR-4081N/P by network for the playback.
 - Up to 4 channels are allowed for simultaneous search and playback.
 - The video information at the time indicated by the timebar will be displayed in the playback screen.



When clicking, it changes to the remote mode.



- Calendar Window



- If the video data in on-line SHR-4081N/P was recorded, the date turns red.
- If you click the date in red, the saved video information is displayed.
- The currently selected date will be marked with a thick red box.
- ◀ : Moves to the previous month.
- ▶ : Moves to the next month.

- Audio Volume Control, Video Brightness/Contrast Control Buttons



- Same as the control function of Monitoring Mode
- Windows 98 or ME does not support this Brightness/Contrast function.

- Screen Split Selection Button

- Full Screen / Single / Quad / Nine-split / Sixteen split mode



Note

9 partition and 16 partition modes cannot be used in the Remote Mode. And 4 partition, 9 partition, and 16 partition modes cannot be used in the Local Mode.

- Video Save(Backup) / Video Conversion / Print / Setup



- ① Video save button

- During the playback(Play/Reverse Play/Fast Forward/Fast Backward),
- If you select a channel in the playback and click the SAVE button, the video is saved in a file format with the extension of *.dvr in a designated folder of your PC.
- The directory in which an image will be saved, the file name, and the video length to be saved can be set at the Setup Mode → Viewer Setup.
- The video length to be saved can be set from one minute to 10 minutes.
- Click the button again to stop recording. However, manual suspension is prohibited for 10 seconds after recording started.

- ② Backup Button

- If not playback(Stop), the video save button performs the backup function.

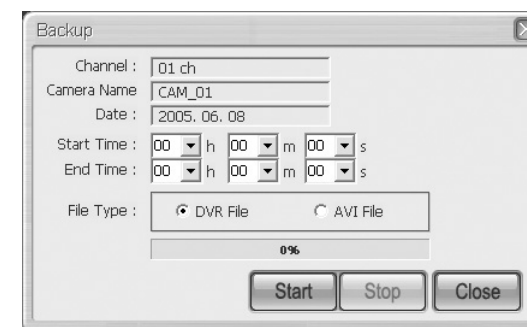

- If the save button is pressed, the window for backup pops up.
- Set a Start/End time for backup and select a file format to save.
- The backup starts when the "Start" button is clicked. The backup file is saved according to the setting route; Setup → Viewer Setup → Video Recording → Video Location.
- To stop the backup, click the "Stop" button.

Note

Video saving in the remote mode is available only when the Play/Reverse Play/Fast Forward/Fast Backward button remains pressed down. The backup function in the remote mode is available at the Stop status.

- ③ File Converting Button

- This function converts *.dvr files into "*.jpg" files.

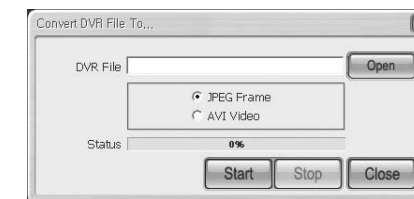

- Click the "Open" button to select a *.dvr file to be converted.
- Select the JPEG Frame or AVI Video.
- If the JPEG Frame is selected, the file is converted into the "*.jpg" file by clicking the "Start" button. The converted "*.jpg" file is saved according to the setting route Setup → Viewer Setup → File Converting → Jpeg Location.
- If the AVI Video is selected, the file is converted into the "*.avi" file by clicking the "Start" button. The converted "*.avi" file is saved according to the setting route Setup → Viewer Setup → File Converting → AVI Location
- Press the "Start" button to convert it to a *.Jpg file. Press Setup → Viewer Setup → File Converting to save the converted *.jpg file.
- Click the Stop button to pause the file conversion.

④ Print

- This function outputs the screen zone of the playback video which is now being displayed.

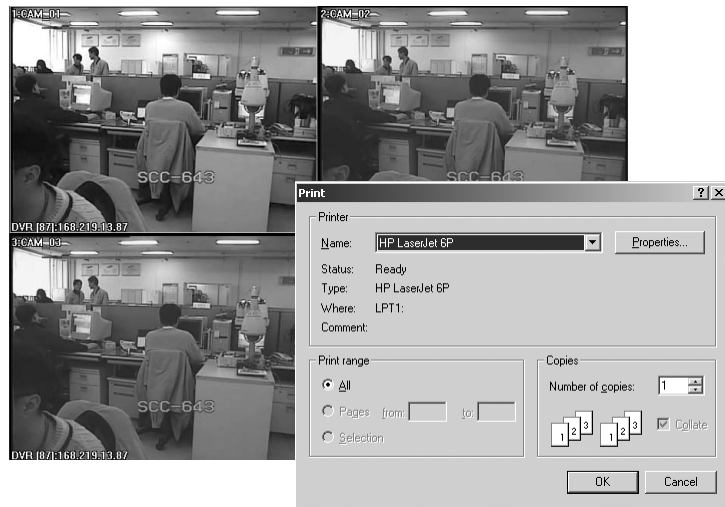

⑤ Setup Mode Button

- This button pops up the setup mode window.

● Play Buttons

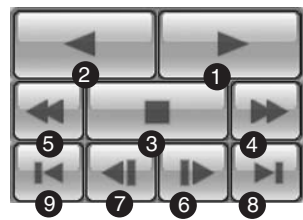

- ① Play : Play
- ② Reverse Play : Reverse Play
- ③ Stop : Stop
- ④ Fast Forward : Faster Play
- ⑤ Fast Backward : Faster Reverse Play
- ⑥ Step Forward : Forward playback per second.
- ⑦ Step Backward : Reverse playback per second.
- ⑧ Go to First : Playback of the first image in the time Line
- ⑨ Go to Last : Playback of the latest(last) image in the time Line

Note

During play(Play/RevPlay/FF/FB), disconnection or entering both Monitoring Mode and Local Mode is not permitted. Click the Stop button first before conversion.

- Time Line
 - Displays the time information on the video data in SHR-4081N/P on the calendar window for the selected day.
 - The General mode indicates the 24 hour information from 0 o'clock to 24 o'clock while the Zoom mode indicates the time information every 2 hours.

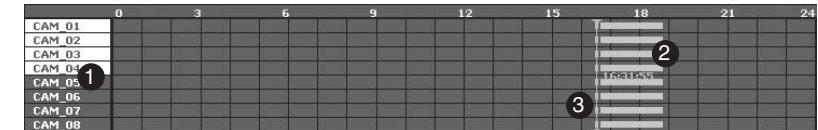

[General Mode]

- ① The channels being displayed in Play Screen will be activated in a white background.
- ② Time Line : The time information on the video data recorded in SHR-4081N/P.
- ③ Time Bar : Displays the current time of the video image being displayed in Play Screen.

Note

Double-clicking the neighborhood of Time Bar enters Zoom In Mode. One column of Time Line represents an hour. Time Line turns Green(Normal), Red(Panic), Orange(Alarm), Blue(Motion), Yellow(Schedule), or Purple(Video Loss) depending on the recording condition.

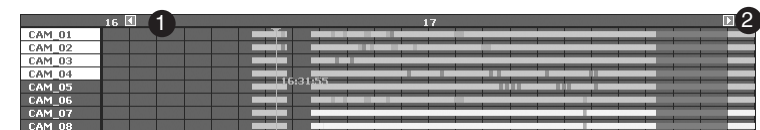

[Zoom In Mode]

- ① Displays the time line one hour ago.
- ② Displays the time line one hour later.

Note

Double-clicking the neighborhood of Time Bar again enters General Mode. One column of Time Line represents 5 minutes. Time Line turns Green(Normal), Red(Panic), Orange(Alarm), Blue(Motion), Yellow(Schedule), or Purple(Video Loss) depending on the recording condition.

9 SETUP MODE

- Next Button



- Changes a channel as the Next button does in Monitoring Mode.

Note

During Video play(Play/RevPlay/FF/FB), channel change is not available.

- Reload Button



- Clicking updates the time information on the video data recorded in the calendar window and Time Line.

- Local Mode

- This mode plays *.dvr files recorded in the directory of your PC by the Record function.
 - You can search and play only one channel.
 - You are free for access to the user being connected to SHR-4081N/P
 - Other functions than the calendar display function are as same as those of Remote Mode.
 - The time information on Local File will be displayed at the first channel position in Time Line together with the file name.



: Clicking selects a file to be played in the file selection window and enters Local Mode.



Note

Only the.dvr files saved by Audio activation can be played in Local Mode.*

- Description of Initial Screen

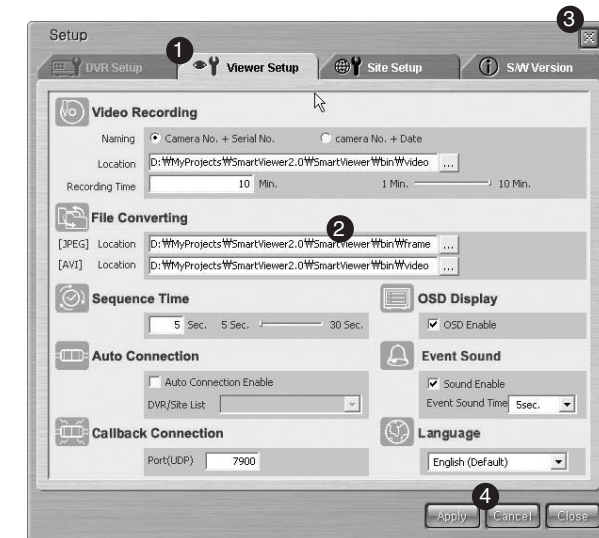

- ① This button is used to select items for DVR Setup, Viewer Setup, Site Setup, and S/W Version setup.
- ② Shows what the selected Setup item can set up in detail.
- ③ This button terminates the Setup window.
- ④ This button saves the information revised in the Setup window, remarks the information prior to such a revision, or terminates the Setup window.

● Setup Item Selection Button



- This button is used for the selection of each Setup item.
- This is composed of 4 items, DVR Setup, Viewer Setup, Site Setup, and S/W Version.
- DVR Setup : DVR Setup allows you to change the remote Menu setup items of SHR-4081N/P.
- Viewer Setup : Viewer Setup allows you to set up various kinds of items concerning operations of Smart Viewer.
- Site Setup : Site Setup allows you to set up SHR-4081N/P information, that is SHR-4081N/P name, IP Address, ID, and Password that you contact through Smart Viewer or register all the registered SHR-4081Ns at a site for control.
- S/W Version : S/W Version shows the current version of Smart Viewer, system requirement, and the System S/W version of on-line SHR-4081N/P and upgrades SHR-4081N/P System S/W remotely.

● Save/Cancellation of Revised Information



- Click the [Apply] button to save the information revised in the Setup window click the [Cancel] button to display the information before such a revision.

● Closing Setup Window



- Click the [X] icon on the top right corner of the Setup window or the [Close] button to close the Setup window.
- If more than one Setup item have been revised before you close the Setup window, the following message box pops up. If you press OK, the revised information will be saved, closing the Setup window but if you press CANCEL, the revised information will be flown away, closing the Setup window.



DVR Setup



- Click the [DVR Setup] button for DVR Setup.
- You can change the setup items of SHR-4081N/P Menu, being connected with Smart Viewer remotely.
- DVR Setup is composed of 5 items, System, Camera/Audio, Monitoring, Recording, and Network.

Note

DVR Setup is for only ADMIN.

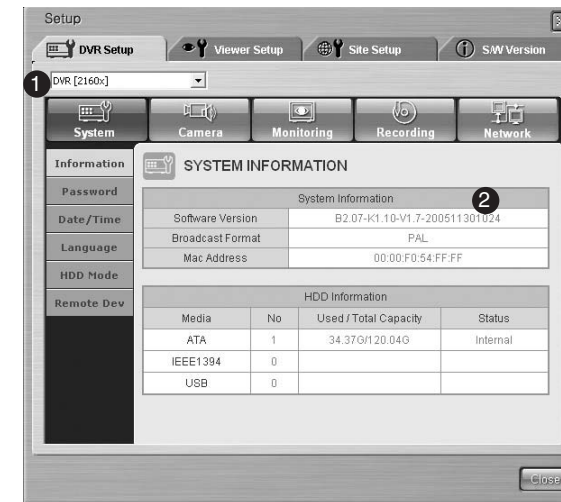

- ① Among more than one on-line SHR-4081N/P, the name of SHR-4081N/P connected in the Admin capacity will be listed. Depending on you are connected to a SHR-4081N/P or the site, the name of SHR-4081N/P or the name of SHR-4081N/P connected in the Admin. capacity among those composing the site will be listed. You may choose one to set up SHR-4081N/P Menu.



- ② The setup menu for selected SHR-4081N/P will be displayed.

- Detailed DVR Setup Items

- ① System

- Information

Information shows the information on on-line SHR-4081N/P.

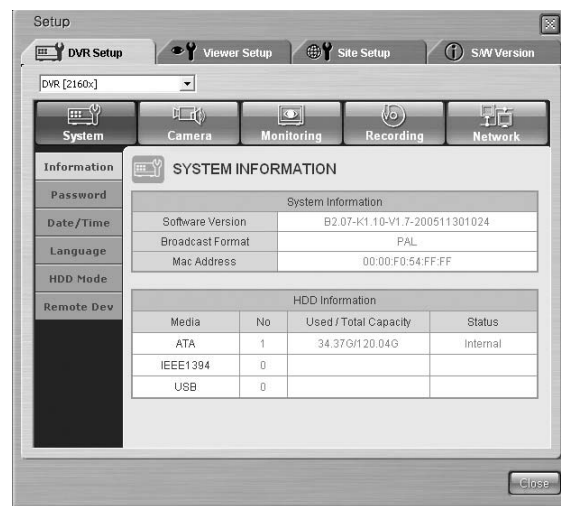

Note

For the detailed items of DVR Setup, refer to Chapter 5, MENU.

- Password

Password determines the password for the control of SHR-4081N/P Menu or SHR-4081N/P key input.



Caution

System Password shall be composed of number only, up to 8 digits.

Note

- The Delete key and the combination of Ctrl+C or Ctrl+V in the keyboard are not supplied to System Password input.
- Use the BACKSPACE key to delete content.

Note

Default System Password is set to 4321.

- Date/Time

Date/Time is used to set up the information on Date, Time, Form, and Summer Time of on-line SHR-4081N/P.

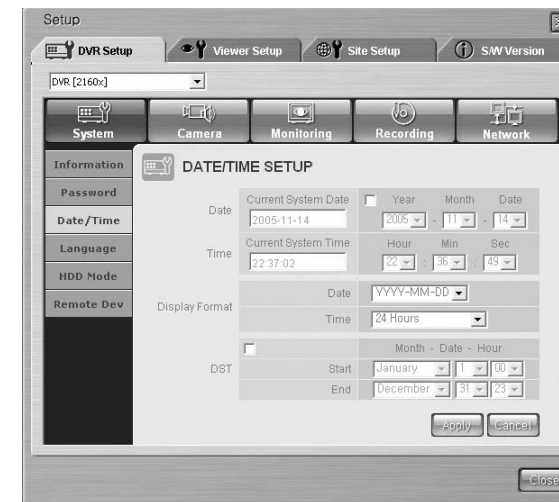

Note

- If you change the Date/Time value, SHR-4081N/P will automatically cut the connection with Smart Viewer to apply a new time setup.
- Upon completion of new time setup of SHR-4081N/P, you are permitted to resume connection with Smart Viewer.
- But, Display Format or DST can be set up without disconnection.

- Language
Language sets up the language in which on-line SHR-4081N/P will be expressed



Note

Language change by SYSTEM LANGUAGE results in change of language expression setup of SHR-4081N/P. In short, the language setup of Smart Viewer does not change. Language specification to be supported is subject to change later.

- HDD Mode
In HDD Mode, you may set up Writing Mode of HDD attached to SHR-4081N/P.



- Remocon (Remote Control Device)
Remocon can set up Remote Control Device fixed to SHR-4081N/P.



Note

If you fix Remote Control Device to the main body of SHR-4081N/P and activate the setting values, Viewer will be disabled to control PTZ.

② Camera

- Config.

Config. sets up Video, Audio On/Off, Camera Title, and Screen change Time for each channel of on-line SHR-4081N/P.

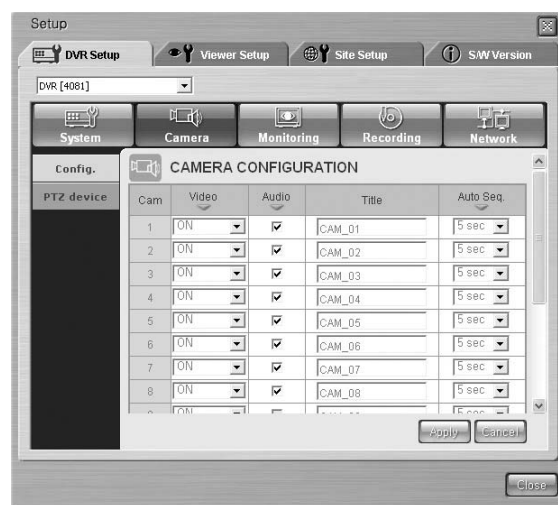

⚠ Caution

- Title supports English only. If you type in and apply Title in your native language, Warning message will pop up to ask your retyping.
- Title shall be composed of no more than 15 texts.
- If you leave Title blank and apply it, Warning message will pop up to ask your retyping.

Note

- The Delete key and the combination of Ctrl+C or Ctrl+V in the keyboard are not supplied to Title input.
- Use the BACKSPACE key to delete content.

- PTZ device

If a dome camera is connected to all channels, sets up Camera ID, Protocol, Baud Rate, Parity, Data Bit, Stop Bit, and Serial Mode.

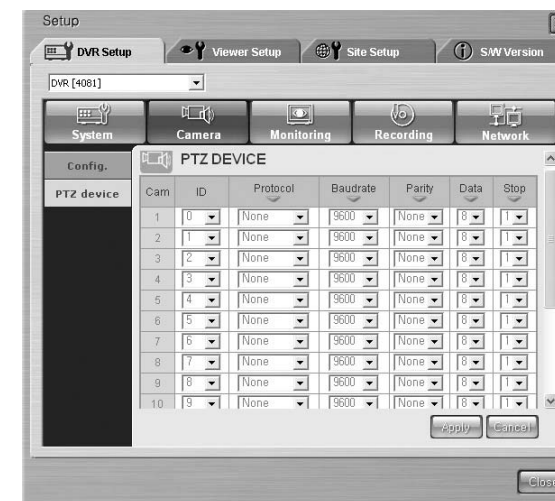

③ Monitoring

- Monitoring

Monitoring sets up both Event Monitoring and OSG Display of Live Mode.



④ Recording

- Rec. Mode

Rec. Mode sets up Live Mode decision, Video Size during recording, Quality, and Rate.

NTSC



PAL

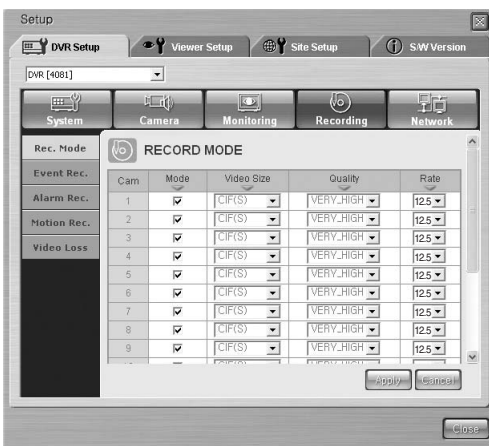

Note

Full D1(L) Video Size does not support 15ips, 10ips(NTSC) / 12.5ips, 8.33 ips(PAL)

- Event Rec.

Event Rec. sets up Video Size, Quality, Rate, Pre Alarm, and Post Alarm values to be recorded when Event occurs.

NTSC



PAL



Note

Full D1(L) Video Size does not support 15ips, 10ips(NTSC) / 12.5ips, 8.33 ips(PAL)

- Alarm Rec.

Alarm Rec. sets up the information necessary for Alarm Recording.

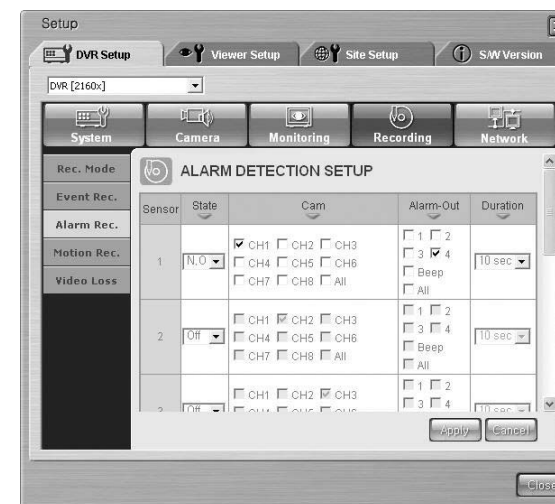

Note

At least one camera should be selected in advance to be coupled with Alarm.

- Motion Rec.

Motion Rec. sets up the information necessary for recording by Motion Detection.

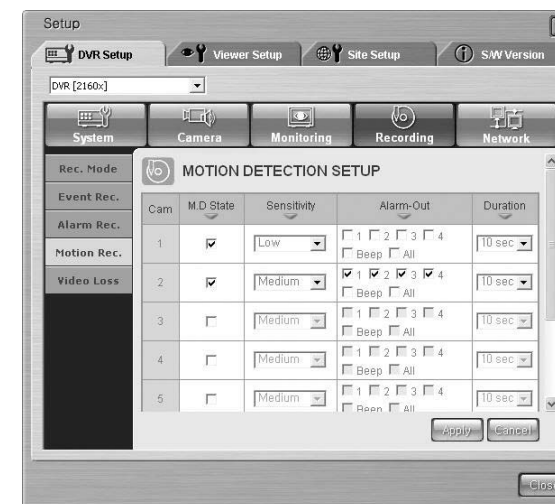

- Video Loss
Video Loss sets up the information on how to inform the user of Video Loss of SHR-4081N/P.



⑤ Network

- Password
This sets up the password for Admin and User to let you connect with SHR-4081N/P through Network in Smart Viewer.



! Caution

- Network Password shall be composed of no more than 8 texts.
- If you leave Password blank and apply it, Warning message will pop up to ask your retyping.

Note

- The Delete key and the combination of Ctrl+C or Ctrl+V in the keyboard are not supplied to Network Password input.
- Use the BACKSPACE key to delete content.

Note

- Default Admin Password is set to 654321.
- Default User Password is set to 654321.

- Configuration

Sets up the network connection method of SHR-4081N/P. SHR-4081N/P supports the connection with Static IP, Dynamic IP, and ADSL(PPPoE). Sets up the network Bandwidth. Please adjust the bandwidth to the network condition in which SHR-4081N/P is connected. Sets up IP Address, Gateway, Subnet Mask, and DNS. Please input both ID and password of the sub scriber in the event of ADSL.



! Caution

- Be sure to inquire the network manager before you input Network IP, Gateway, Subnet Mask, or DNS.
- Both ADSL ID and Password can be input in alphabets, numbers, and symbols without discrimination as long as 40 digits and 40 digits respectively.

- Callback

- Sets up the Callback functions of SHR- 4081N/P.
- Sets up the IP address and port to which SmartViewer was installed to deliver the Callback message in the event of Alarm, Motion Detection, or Video Loss. Sets up the value for retrial in the event of message delivery failure.

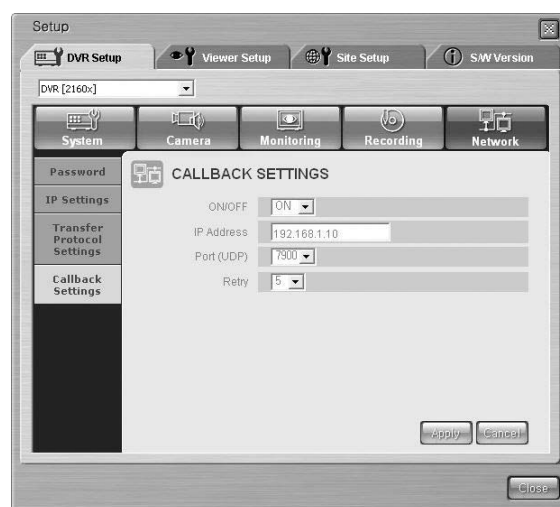

- Translation Protocol

- Changes the Transmission Protocol setting values. The protocol supports TCP/IP and UDP(Unicast, Multicast). Control Port(TCP/IP) and Port(UDP) to change the connection port. Multicast IP or TTL will be used for UDP(Multicast).

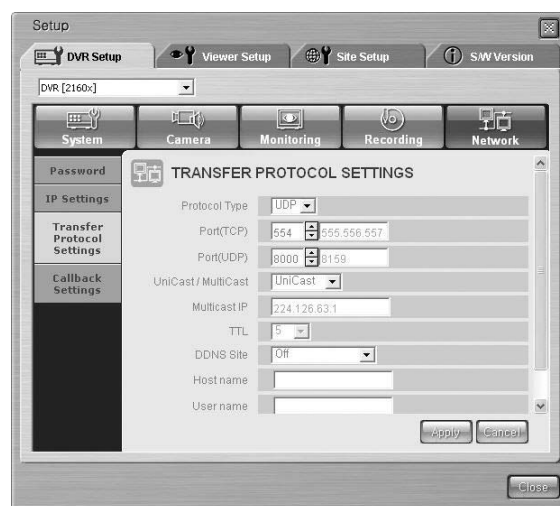

Note

- SHR-4081N/P uses 4 PORTs for TCP connection.
- A PORT number is flexible and 4 numbers in a row will be changed in all. (554,555,556,557 → 558,559,560,561)
- You shall allocate the above ports for SHR-4081N/P if you want to compose a network by IP Router.

Viewer Setup



- Click the [Viewer Setup] for Viewer Setup.
- Viewer Setup sets up various kinds of items related to Smart Viewer motions.
- Viewer Setup is consisted of 7 items : Video Recording, File Converting, Sequence Time, OSD Display, Auto Connection, Callback Connection, and Language.

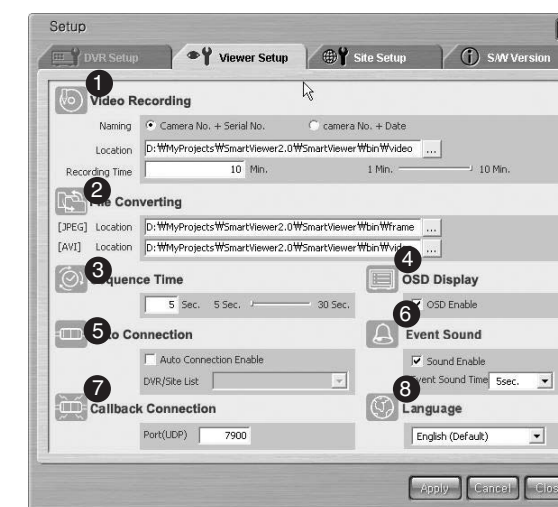

- ① This is used for the setup of information necessary for saving the video data in display in *.dvr file format while you are connected to SHR-4081N/P.
- ② This is used for the setup of information necessary for converting the file saved in your PC in *.dvr file format into JPEG.
- ③ This is used for the setup of information necessary for Screen change Mode.
- ④ This is used for the setup of information on OSD display for Smart Viewer.
- ⑤ This determines whether Smart Viewer shall be automatically connected to DVR(SHR-4081N/P) or Site when it begins running.
- ⑥ This is a menu item that is designed to set the alarming time when it receives an event message such as an alarm, motion and/or Video loss.
- ⑦ Selects the port to allow the connection of Callback.
- ⑧ This item is for the language setup.

- Video Recording

- ① Naming

Camera No. + Serial No. Camera No. + Date

- Being connected to SHR-4081N/P in Monitoring or Search Mode, you can save the video data in display in *.dvr file format. This determines how to name *.dvr file format.
- The file name depends on camera number and serial number, set to "Camera No. + Serial No." or camera number, current date, and time, set to "Camera No. + Date".

- ② Location

C:\Program Files\Samsung\SHR-4081N/P Sma ...

- As long as you are connected to SHR-4081N/P in Monitoring or Search Mode while recording the video data in display, this sets up a directory where *.dvr file format will be saved.
- The current default directory is "Smart Viewer Program Installed Directory \video\dvr".

- ③ Recording Time

1 Min. 1 Min. 10 Min.

- As long as you are connected to SHR-4081N/P in Monitoring or Search Mode while recording the video data in display, this sets up the longest recording time.
- Time setup ranges from 1 to 10 minutes. If recording exceeds the preset time at Recording Time, recording will be automatically stopped.

- File Converting

[JPEG]

- ① Location

C:\Program Files\Samsung\SHR-4081N/P Sma ...

- You can convert the files saved in your PC in *.dvr file format into JPEG format files then the frames composing *.dvr file format will be converted into JPEG format files. Now, this designates a directory in which the converted JPEG files will be saved.
- The current default directory is "Smart Viewer Program Installed Directory \frame".

- Sequence Time

10 Sec. 5 Sec. 30 Sec.

- As long as you are connected to SHR-4081N/P in Monitoring Mode while Screen change is dominant, this sets up Screen change Time. The scope of setup ranges from 5 to 30seconds.

- OSD Display

Enable

- Determines if OSD shall be displayed on each channel of Smart Viewer.
- Whether you check "Enable" or not, OSD will appear or not. However, Audio icon, PTZ icon, REC icon, and Alarm/Motion event icon will not be affected by the OSD Display condition.

- Auto Connection

- Determines if Smart Viewer shall be automatically connected to SHR-4081N/P or Site as soon as it starts running.
- If you check "Auto Connection On", the name of SHR-4081N/P and Sites that are currently registered in DVR/Site List will be listed as follows and if you select one, it will be automatically connected to the selected SHR-4081N/P or Site as soon as Smart Viewer starts running.

Auto Connection On

DVR/Site List

-- DVR LIST -----
DVR [216]
DVR [219]
DVR [87]
-- SITE LIST -----
Site [0]
Site [1]

- Callback Connection

Port(UDP) 7900

- Selects the port to allow the connection of Callback.

- Event Sound

Sound Enable

Event Sound Time 5sec.

- This is a menu item that is designed to set the alarming time when it receives an event message such as an alarm, motion and/or Video loss.

- Language

English (Default)

English (Default)
Korean
Chinese
Spanish

- This sets a language for SmartViewer.

Site Setup



- Click the [Site Setup] button for Site Setup.
- Site Setup sets up the information on DVR(SHR-4081N/P) or Site that you want to contact by Smart Viewer.
- Smart Viewer allows you to contact DVR(SHR-4081N/P) or Site registered here.

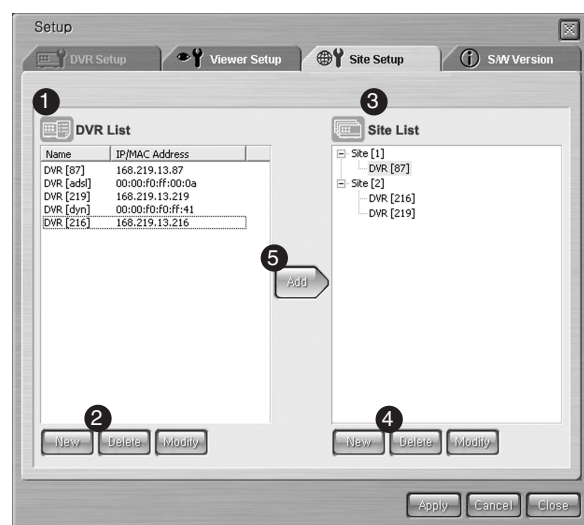

- ① User registered DVR(SHR-4081N/P) list will be displayed here.
- ② This button adds a new DVR(SHR-4081N/P) or deletes or revises the already-registered DVR(SHR-4081N/P).
- ③ User registered Site list will be displayed here.
- ④ This button adds a new site or deletes or revises the already-registered Site.
- ⑤ This button adds DVR(SHR-4081N/P) selected from DVR List to the Site selected from Site List.

- DVR List

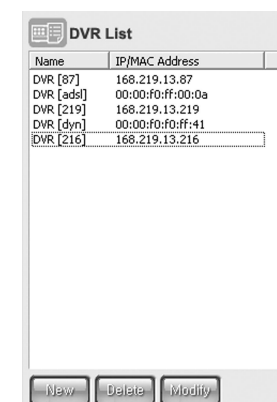

- DVR List sets up the information on DVR(SHR-4081N/P) that you want to contact by Smart Viewer.
- You can register a new DVR (SHR-4081N/P), delete or modify a selected DVR (SHR-4081N/P) from the registered list. In DVR list, the name of the registered DVR (SHR-4081N/P) and IP/MAC Address/URL are shown in the list.

- If your DVR (SHR-4081N/P) uses a static IP, select "Static IP" for Address Type and type in the name of the DVR (SHR-4081N/P) and the IP address.
- Select "Port" so that it matches the port number that you've set in the network menu of DVR (SHR-4081N/P).

The screenshot shows the 'New DVR' dialog box. Under 'DVR Information', 'Address Type' is set to 'Static IP'. The 'Name' field contains 'DVR'. The 'IP Address' field is set to '0 . 0 . 0 . 0'. The 'MAC Address' field is set to '00 00 00 00 00 00'. The 'Port No.' is set to '554,555,556,557'. Under 'Login Information', 'Admin' is selected. The 'Password' field is empty. 'OK' and 'Cancel' buttons are at the bottom.

- If your DVR (SHR-4081N/P) uses a dynamic IP such as in a cable modem or VDSL, or PPPoE for ADSL, select "MAC Address" for Address Type and type in the MAC address of the DVR (SHR-4081N/P).
- Select "Port" so that it matches the port number that you've set in the network menu of DVR (SHR-4081N/P).

The screenshot shows the 'New DVR' dialog box. Under 'DVR Information', 'Address Type' is set to 'MAC Address'. The 'Name' field contains 'DVR'. The 'URL' field contains 'http0011.websamsung.net'. The 'MAC Address' field is set to '00 00 00 00 00 00'. The 'Port No.' is set to '554,555,556,557'. Under 'Login Information', 'Admin' is selected. The 'Password' field is empty. 'OK' and 'Cancel' buttons are at the bottom.

- If you select "Use DDNS" in the network settings menu of DVR (SHR-4081N/P) or use an IP splitter to register an URL using DDNS, you can make connection via the URL.
- If you want to make connection via the an URL, select "URL" for Address Type and type in the URL set for the DVR or IP splitter in the URL menu item.
- Select "Port" so that it matches the port number that you've set in the network menu of DVR (SHR-4081N/P).

The screenshot shows the 'New DVR' dialog box. Under 'DVR Information', 'Address Type' is set to 'URL'. The 'Name' field contains 'DVR'. The 'URL' field is empty. The 'MAC Address' field is set to '00 00 00 00 00 00'. The 'Port No.' is set to '554,555,556,557'. Under 'Login Information', 'Admin' is selected. The 'Password' field is empty. 'OK' and 'Cancel' buttons are at the bottom.

Note

- DVR MAC Address is written in the side label of the product.
It is also found in System Information of DVR Menu.

② Deletion of Already-Registered DVR(SHR-4081N/P)



- If you select one DVR(SHR-4081N/P) in DVR List for deletion and press the [Delete] button, the following message box will pop up. If you press [OK] button then, DVR(SHR-4081N/P) will be deleted.

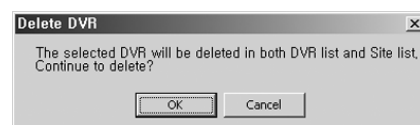

- As long as DVR(SHR-4081N/P) for deletion is connected with the current Smart Viewer, the following message box will pop up and DVR(SHR-4081N/P) will not be deleted. Be sure to cut the connection between DVR(SHR-4081N/P) and Smart Viewer before you delete it.



③ Modification of Already-Registered DVR(SHR-4081N/P)



- If you select one DVR(SHR-4081N/P) in DVR List for modification and press the [Modify] button, the following message box will pop up. If you press [OK] button then, DVR(SHR-4081N/P) will be modified.

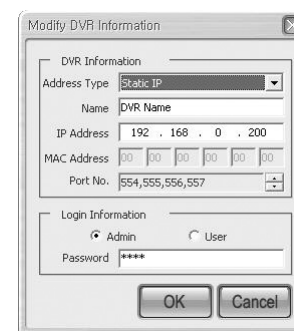

- As long as DVR(SHR-4081N/P) for modification is connected with the current Smart Viewer, the following message box will pop up and DVR(SHR-4081N/P) will not be modified. Be sure to cut the connection between DVR(SHR-4081N/P) and Smart Viewer before you modify it.



● Site List

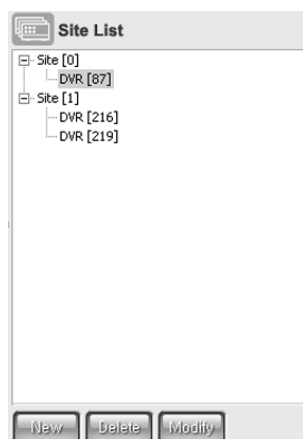

- Site List registers multi- DVRs(SHR-4081N/P) that you want to contact at once by Smart Viewer at one site for control. You are allowed to register a new Site or delete or modify the selected Site from the registered list and add DVR (SHR-4081N/P) to the Site selected from Site List or delete it
- In Site List, both the name of a registered Site and the name of DVR (SHR-4081N/P) composing the Site will be listed. In addition, a Site can be configured with up to 16 DVRs (SHR-4081N/P).

① Site Addition



- If you press the [New] button, the following window will pop up where you can input the information on the new Site.
- The information to be typed in is the Site name.

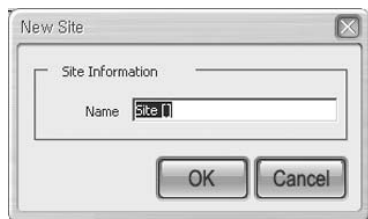

Note

Site may be named in both English and Korean with no more than 10 texts.

② Deletion of Already-Registered Site or DVR(SHR-4081N/P)



- If you select one Site or DVR(SHR-4081N/P) in Site List for deletion and press the [Delete] button, the following message box will pop up. If you press [OK] button then, either Site or DVR(SHR-4081N/P) will be deleted.
- After being deleted, DVR(SHR-4081N/P) is still left alive in the Site composition and so is the information on DVR(SHR-4081N/P).

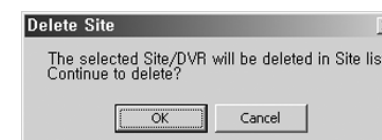

- As long as Site or DVR(SHR-4081N/P) for deletion is connected with the current Smart Viewer, the following message box will pop up and Site or DVR(SHR-4081N/P) will not be deleted. Be sure to cut the connection between both Site and DVR(SHR-4081N/P) and Smart Viewer before you delete it.



③ Modification of Already-Registered Site



- If you select one Site in Site List for modification and press the [Modify] button, the following message box will pop up where you can modify the Site information.



- As long as Site for modification is connected with the current Smart Viewer, the following message box will pop up and Site will not be modified. Be sure to cut the connection between Site and Smart Viewer before you modify it.



- If you select one DVR(SHR-4081N/P) and press the [Modify] button, the following message box will pop up and modification to DVR(SHR-4081N/P) is prohibited. Modification to DVR(SHR-4081N/P) shall be done only in DVR List.



● DVR(SHR-4081N/P) Addition to Site



- If you press the [Add] button, DVR(SHR-4081N/P) selected from DVR List will be added to the Site selected from Site List. Site addition to DVR(SHR-4081N/P) set to ADSL is prohibited.
- A Site can be configured with up to 16 DVRs (SHR-4081N/P), and the DVR (SHR-4081N/P) that configures the Site can be deleted from the Site List.
- If you press the [Add] button unless a Site is registered in Site List, a new Site naming "Site [0]" as a default will be created to which DVR(SHR-4081N/P) will be added.
- As long as Site for DVR(SHR-4081N/P) addition is connected with the current Smart Viewer, the following message box will pop up and DVR(SHR-4081N/P) will not be added to the Site. Be sure to cut the connection between Site and Smart Viewer before the addition

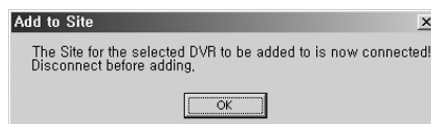

S/W Version



- If you press the [S/W Version] button, Smart Viewer version, system requirements, and the version of DVR(SHR-4081N/P) System S/W, being connected to Smart Viewer, if ever will be displayed.
- You can upgrade the on-line DVR(SHR-4081N/P) System S/W remotely. You are authorized with S/W upgrade in an Admin capacity only. In the capacity of user or if you are isolated with DVR(SHR-4081N/P), your access will be denied.



- ① Smart Viewer Version and system requirements will be displayed.
- ② Here displays the version and name of DVR if any DVR(SHR-4081N/P) is being connected with Smart Viewer. You are also able to upgrade DVR (SHR-4081N/P) S/W by transmitting it to on-line DVR(SHR-4081N/P).

● Smart Viewer Version

Version	SMARTVIEWER-V2.0(20050126)	
System Requirements	OS	Windows 98 SE (or) Windows 2000 (or) Windows XP
	CPU	P3 1GHz (P4 2GHz (or Higher) Recommended)
	RAM	256Mb
	VGA RAM	32Mb (64Mb (or Higher) Recommended)
	DirectX	8.1

- Smart Viewer Version and system requirements will be displayed.

● DVR Version

DVR Name	S/W Version	Status
<input type="checkbox"/> DVR [216]	SHR-4081N/P MAIN-V0.5-200501261626	Connected
DVR [219]	Unknown	Not Connected

- DVR Version not only displays the connected DVR(SHR-4081N/P) name if any DVR(SHR-4081N/P) is being connected with Smart Viewer or the name of DVR(SHR-4081N/P) composing a site if any DVR(SHR-4081N/P) is being connected with the site but also displays DVR(SHR-4081N/P) S/W version.
- Smart Viewer will be expressed in gray when disconnected from DVR(SHR-4081N/P) and Status will be marked as "Not Connected".
- Each DVR Version has a check box, which is used for S/W Upgrade.

● DVR(SHR-4081N/P) S/W Upgrade

- Smart Viewer upgrades on-line DVR(SHR-4081N/P) S/W remotely.

- ① Check a DVR(SHR-4081N/P) to be upgraded among DVRs(SHR-4081N/P) on line.

DVR Name	S/W Version	Status
<input checked="" type="checkbox"/> DVR [216]	SHR-4081N/P -MAIN-V0.5-200501261626	Connected
DVR [219]	Unknown	Not Connected

- ② Click the following button to open the "SHR-4081N/P Firmware" file in tgz format.

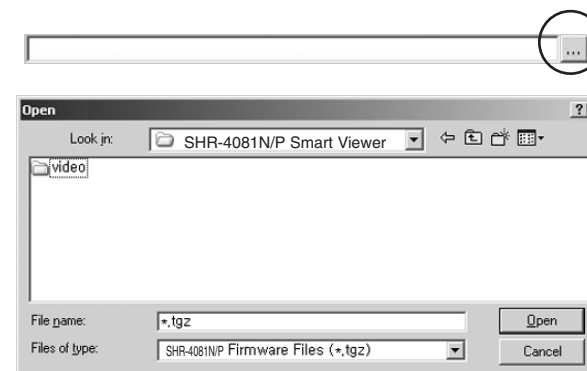

- ③ Press the [Upgrade] button to transmit a file to the selected DVR (SHR-4081N/P) and start upgrade of DVR(SHR-4081N/P) S/W.



- ④ The progress of file transmission and upgrade will be displayed at the bottom.



! Caution

Be sure to suspend all the DVR system functions in action such as recording, MENU, backup, and play before you upgrade DVR(SHR-4081N/P) S/W. Never try to turn the DVR(SHR-4081N/P) power off during such S/W upgrade. S/W upgrade requires about 5 minutes. If S/W upgrade is suspended accidentally, the previous S/W will be left intact.

Note

The new Firmware necessary for DVR(SHR-4081N/P) S/W upgrade shall be downloaded from CCTV Part in Products Section at <http://www.samsung.com>



Chapter 11

Backup Viewer

1 Introduction

In SHR-4081N/P, you can back up the video data by using External HDD, USB Memory, and CD. In the Backup Viewer, the backup image data can be searched or played in the PC through the CD/DVD or connecting the external HDD, USB Memory to the user's PC.

2 Features

- The video data backed up in any method among External HDD, USB Memory, and CD can be searched or played in your PC.
- Backup Viewer is optimized in the resolution of 1024 x 768.

3 PC Specification(Recommendation)

- OS: Windows 2000, Windows XP
- Recommendation :
 - CPU Pentium 3 1GHz or higher
 - RAM 256Mb or higher
 - VGA RAM 16Mb or higher
 - Direct X 8.1 or higher

4 Backup Viewer Installation

- Put the Smart Viewer Program CD in CD-ROM and open the "Backup Viewer" folder in the CD.

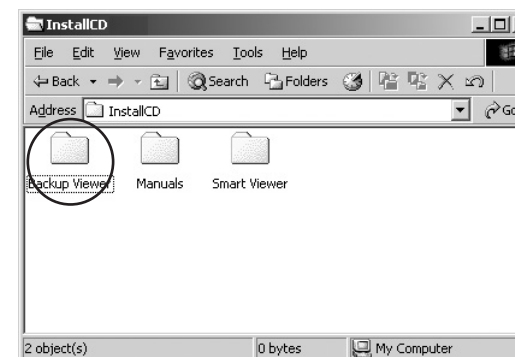

- Run the "Setup.exe" file.

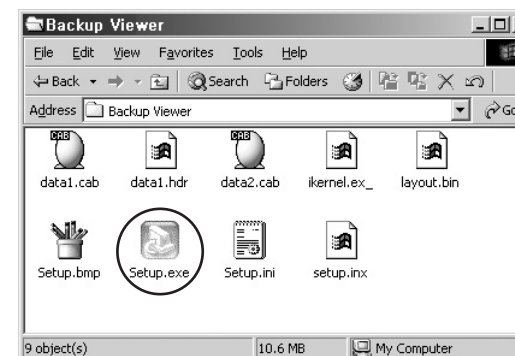

- Click "Next".

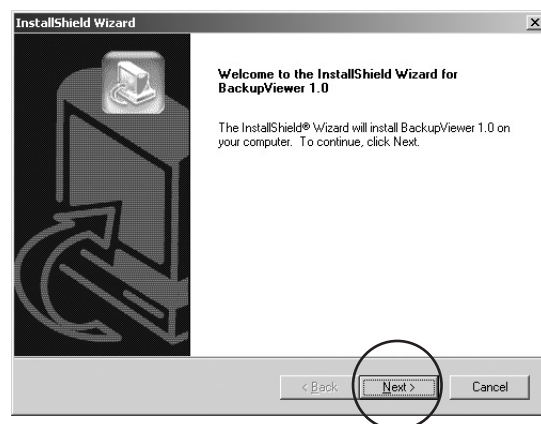

- If you agree with the Backup Viewer license, click "Yes".

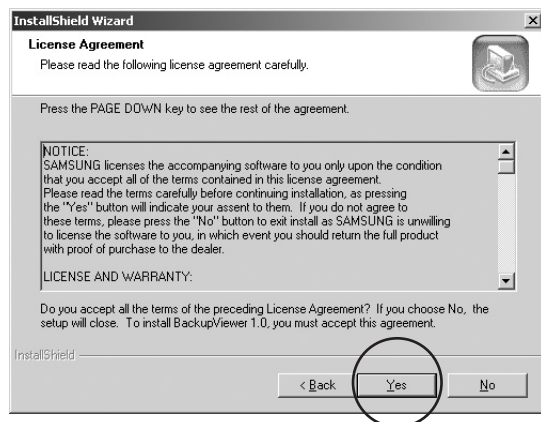

- Select a folder to install Backup Viewer and click "Next".

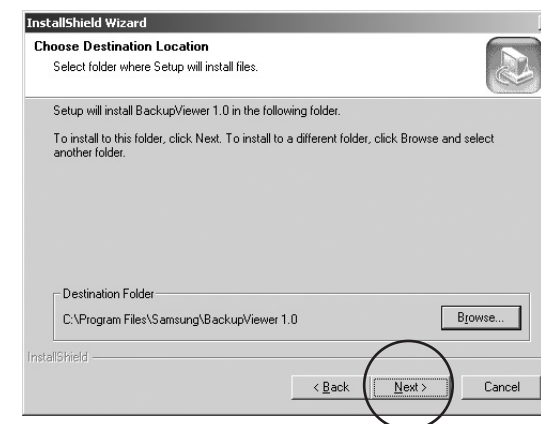

- Install the execution file and set up the system as necessary.

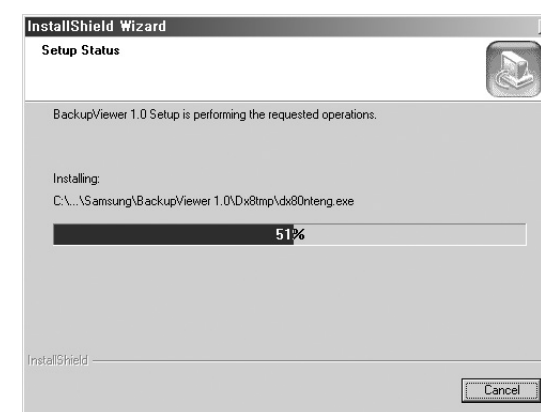

5 Executing Backup Viewer Program

- Installation is complete. Click "Finish" to terminate the whole installation process.

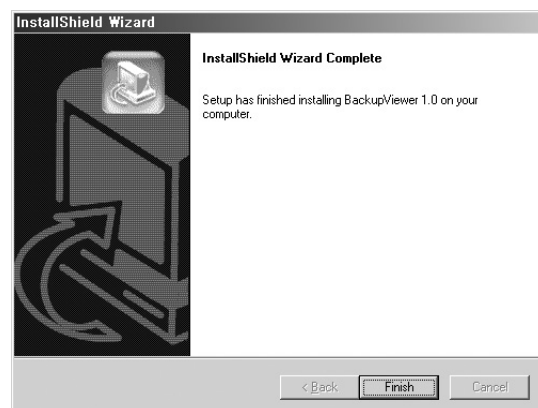

- Double-click the Backup Viewer 1.0 icon in the background screen to execute the program.

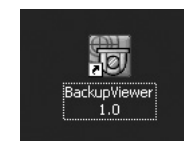

6 Initial Screen of Backup Viewer

- Description



- ① Terminates or minimizes the program.
- ② Displays the current date, weekday, and time.
- ③ Selects a device(External HDD, USB Memory, or CD/DVD) for connection.
- ④ Displays the image in play.
- ⑤ Selects the "Year/Month/Date" that you wish to search.
- ⑥ Controls Audio volume and Video brightness/contrast.
- ⑦ Plays the searched images.
- ⑧ These are buttons for CH change and update of the Calendar window and Timeline.
- ⑨ Displays the time when a video file was recorded in External HDD, USB Memory, and CD/DVD for the search date.

7 Using Backup Viewer

- Connecting

Connecting means you may access and search the video data recorded in External HDD, USB Memory, or CD/DVD installed in your PC. Select a device that you wish to connect and click the Connecting button.



- Connecting Screen



- Display of Time

2005.02.14.MON
PM 09:50.37

- Displays the date, weekday, and time of your PC.

- Display of Connection

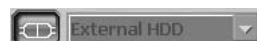

- When connected to the device installed in your PC, the Connecting button indicates the connecting condition.
- Click the Connecting button for disconnection.

- Display of Play Screen OSD

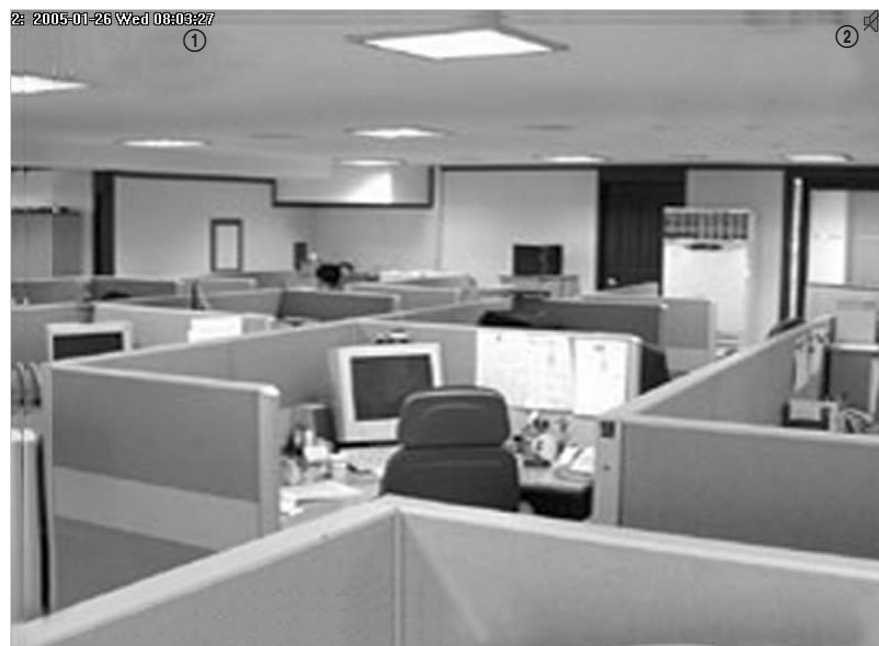

- ① Displays the CH number and replay time.
- ② Displays the Audio On/Off button.

Note

If the video file in play has an audio image, the Audio icon will be enabled to turn Audio on/off.

: Audio Off : Audio On

If the video file in play has no audio image, the Audio icon will be disabled.

: Audio Disable

If Audio is turned on, you can control the volume or select Mute.

- Calendar Window

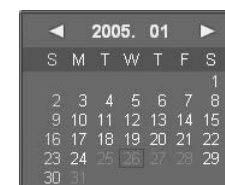

- The date when the video data was recorded in the current device is displayed in red.
- Click the red colored date to display the video information in Timeline.
- A thick red box will be displayed in the current date.
- ◀ : Moves to the previous month.
- ▶ : Goes on to the next month.

- Audio Volume Control



- If you play a video file with audio recorded in, you can control the audio volume or select Mute.
- The audio volume can be controlled by 10 steps from 0 to +10.

- Brightness / Contrast



- You can control the brightness and contrast of the file in play.
- The default is +5.
- The brightness and contrast can be controlled by 10 steps from 0 to +10.
- Press the button to return to the default.

- Play Buttons

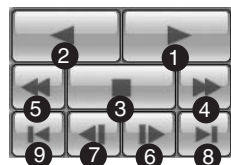

- ① Play
- ② Reverse Play
- ③ Stop
- ④ Fast Forward
- ⑤ Fast Backward
- ⑥ Step Forward : Forward by 1 second
- ⑦ Step Backward : Backward by 1 second
- ⑧ Go to Last : Plays the first image of Timeline.
- ⑨ Go to First: Plays the recent(last) image of Timeline.

Note

*Disconnect is not available during (Play/Reverse Play/Fast Forward/Fast Backward).
In this case, click the Stop button.*

- Timeline

- Displays the time when the video image was recorded in the current device for the date selected from the Calendar window.
- The General mode displays the information for 24 hours from 0 to 24 o'clock and the Zoom mode displays the time information every 2 hours.



[General Mode]

- ① This mode is displayed in the Play screen and the CH will be activated in the white background.
- ② Timeline: Displays the time information on the video data recorded in the current device.
- ③ Time Bar: Displays the current time of the video image in play.

Note

*Double-click the Time Bar surrounding area to return to the Zoom mode.
Each column of Timeline corresponds to one hour.
The Timeline color changes according to the recording condition, Green(Normal), Red(Panic), Orange(Alarm), Blue(Motion), Yellow(Schedule), or Purple(Video Loss).*

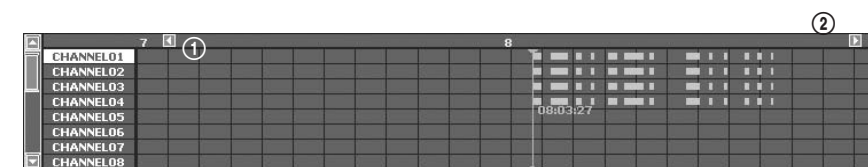

[Enlargement Mode]

- ① Displays the timeline one hour earlier.
- ② Displays the timeline one hour later.

Note

*Double-click the Time Bar surrounding area to return to the General mode.
Each column of Timeline corresponds to 5 minutes.
The Timeline color changes according to the recording condition, Green(Normal), Red(Panic), Orange(Alarm), Blue(Motion), Yellow(Schedule), or Purple(Video Loss).*

- Next Button



- Displays the next channel.

Note

Channel change is not available in the process of (Play/Reverse Play/Fast Forward/Fast Backward).



Appendix

1 Product Specification

Item	Specification	Remark						
CPU	32bit RISC CPU							
Memory	SDRAM : 128MByte Flash : 16 MByte							
Operation System	Embedded OS							
Broadcasting	NTSC System							
Input Voltage	AC 110-220V(NTSC) / 100-230V(PAL)							
Power Consumption	85 Watt Max							
Video	Video Input	Composite 8 Channel - 1.0Vp-p - 75Ω Hi Z Termination BNC Type Loop Through Out 8 Channel - Auto Termination						
	Video Output	Composite 2 Channel - Normal Video Output 1 Channel - Spot Output 1 Channel - BNC Type S-Video 1 Channel - 1.0Vp-p VGA 1 Channel						
Audio	Audio Input	Mono 8 Channel - -5dBm, 600Ω RCA Type						
	Audio Output	Mono 1 Channel - -6dBm RCA Type						
Live Monitoring	Resolution & Frame Rate	<table border="1"> <thead> <tr> <th>Resolution</th> <th>Frame Rate (1Ch/8Ch)</th> </tr> </thead> <tbody> <tr> <td>720X480(NTSC)</td> <td>30fps/240fps(NTSC)</td> </tr> <tr> <td>720X576(PAL)</td> <td>25fps/200fps(PAL)</td> </tr> </tbody> </table>	Resolution	Frame Rate (1Ch/8Ch)	720X480(NTSC)	30fps/240fps(NTSC)	720X576(PAL)	25fps/200fps(PAL)
	Resolution	Frame Rate (1Ch/8Ch)						
720X480(NTSC)	30fps/240fps(NTSC)							
720X576(PAL)	25fps/200fps(PAL)							
Display Mode	Single Quad Multi Screen : 6, 7, 8, 9 PIP Sequence Mode Freeze 2x Zoom Change the channel location (4, 6, 7, 8 PIP Division)							

Item	Specification	Remark													
Recording	Compression	Video : MPEG4 Audio : G.726													
	Resolution & Performance	<table border="1"> <thead> <tr> <th>Resolution</th> <th>Quality Level</th> <th>Max Image Rate</th> </tr> </thead> <tbody> <tr> <td>CIF(C) 352X240(NTSC) /352X288(PAL)</td> <td>Very High High Standard Low</td> <td>30ips(NTSC)/ 25ips(PAL)</td> </tr> <tr> <td>Half D1(N) 720X240(NTSC) /720X288(PAL)</td> <td>Very High High Standard Low</td> <td>15ips(NTSC)/ 12.5ips(PAL)</td> </tr> <tr> <td>Full D1(L) 352X240(NTSC) /352X288(PAL)</td> <td>Very High High Standard Low</td> <td>7.5ips(NTSC)/ 6.25ips(PAL)</td> </tr> </tbody> </table>	Resolution	Quality Level	Max Image Rate	CIF(C) 352X240(NTSC) /352X288(PAL)	Very High High Standard Low	30ips(NTSC)/ 25ips(PAL)	Half D1(N) 720X240(NTSC) /720X288(PAL)	Very High High Standard Low	15ips(NTSC)/ 12.5ips(PAL)	Full D1(L) 352X240(NTSC) /352X288(PAL)	Very High High Standard Low	7.5ips(NTSC)/ 6.25ips(PAL)	*ips (image per sec)
		Resolution	Quality Level	Max Image Rate											
		CIF(C) 352X240(NTSC) /352X288(PAL)	Very High High Standard Low	30ips(NTSC)/ 25ips(PAL)											
Half D1(N) 720X240(NTSC) /720X288(PAL)	Very High High Standard Low	15ips(NTSC)/ 12.5ips(PAL)													
Full D1(L) 352X240(NTSC) /352X288(PAL)	Very High High Standard Low	7.5ips(NTSC)/ 6.25ips(PAL)													
If the video size is CIF and the camera has an odd number, 30 ips is supported.															
Recording Mode	Normal → REC Key Emergency → PANIC Key Schedule → Schedule Table Event -Alarm Detection -Motion Detection -Video Loss -Pre & Post Recording														
Time Laps	NTSC : 1ips/3ips/5ips/7.5ips/10ips/15ips/30ips PAL : 1ips/2.5ips/5ips/6.25ips/8.33ips/12.5ips/25ips														
Storage Capacity	Internal	ATA HDD x 4(MAX) -Primary/Secondary IDE Connector -MAX HDD Size : 250GB x 4 = 1Tera Byte													
	External	IEEE1394 HDD -MAX 6 (Daisy chain connection) -MAX HDD Size : 250GB x 6 = 1.5Tera Byte USB HDD -MAX 1 (Not support USB Hub) -MAX HDD Size : 250													

Item		Specification	Remark														
Play Back	Search Mode	Calendar Event - Normal, Panic, Schedule, Alarm, Motion, Video Loss Date/Time Go to First Go to Last Backup Data															
	Resolution & Performance	<table border="1"> <thead> <tr> <th rowspan="2">Resolution</th> <th colspan="2">Decoding Performance</th> </tr> <tr> <th>1Ch</th> <th>4Ch</th> </tr> </thead> <tbody> <tr> <td>CIF</td> <td>30ips(NTSC)/25(PAL)</td> <td>30 ips/1Ch</td> </tr> <tr> <td>Half D1</td> <td>15ips(NTSC)/12.5(PAL)</td> <td>15 ips/1Ch</td> </tr> <tr> <td>Full D1</td> <td>7.5ips(NTSC)/6.25(PAL)</td> <td>7.5 ips/1Ch</td> </tr> </tbody> </table>	Resolution	Decoding Performance		1Ch	4Ch	CIF	30ips(NTSC)/25(PAL)	30 ips/1Ch	Half D1	15ips(NTSC)/12.5(PAL)	15 ips/1Ch	Full D1	7.5ips(NTSC)/6.25(PAL)	7.5 ips/1Ch	
		Resolution		Decoding Performance													
			1Ch	4Ch													
		CIF	30ips(NTSC)/25(PAL)	30 ips/1Ch													
Half D1	15ips(NTSC)/12.5(PAL)	15 ips/1Ch															
Full D1	7.5ips(NTSC)/6.25(PAL)	7.5 ips/1Ch															
Display Mode	Single → 1Channel Decoding Quad → 4Channel Decoding PIP → 1Channel Decoding + 1Channel Live - Change the live channel. Multi Screen → 8 Channel live + 1Channel Decoding																
Play Mode	Play, Pause, Stop, 2x Digital Zoom Fast Forward/Fast Reverse - 2x, 4x, 8x, 16x, 32x, 64x Still Jog → Still Shuttle → Fast Forward/Fast Reverse																
Backup	IEEE1394 External HDD SCSI External HDD USB CD/DVD Writer USB Flash Memory																
Alarm	Input : 8 Input - 5mA Output : 4 Relay Output - 2A/30VDC, 0.5A/125VAC Reset : 1 Input - 5mA																
Network	Ethernet : 10/100 Base T, ADSL(PPPoE), DHCP																
Serial I/F	RS-485 → PTZ Device Control, Remote Control Device																
Remote Viewer	PC Spec.	CPU : Pentium III, 1GHz or higher RAM : SDRAM 256MB or higher Graphic Accelerator : Graphic Memory 32MB or higher DirectX : 8.1 or higher															
	Support OS	Win2000, WinXP															
	Function	Live Image Monitoring Mode Local File Search & Play Back Mode Remote File Search & Play Back Mode															
Backup Viewer	PC Spec.	Same as Remote Viewer															
	Support OS	Win2000, WinXP															
	Function	Backup device(External HDD, USB Memory, CD/DVD) search and replay mode															
Input Voltage	SHR-4081N : AC 120V (60Hz) SHR-4081N(SHR-4081N/JPN) : AC 100-230V (50/60Hz) SHR-4081P : AC 100-230V (50/60Hz)																
Input Current	SHR-4081N : 4A SHR-4081N(SHR-4081N/JPN) : 4 ~ 2A SHR-4081P : 4 ~ 2A																
Max Power Consumption	MAX 200W																
Operation Temp.	0°C ~ 40°C																
Preservation Temp.	-20°C ~ 60°C																
Operation Humidity	20% ~ 85% RH																
Preservation Humidity	20% ~ 85% RH																
Size	430(W) X 88(H) X 400(D)																
Weight	About 7.1Kg																

2 HDD Specifications

• ATA HDD

Maker	Capacity	RPM	Interface	Buffer	Series Name	Model Name	Remark
Samsung	160GB	5400	IDE, P-ATA	2MB	Spinpoint	SV1604E	
	200GB	7200	IDE, P-ATA	8MB	Spinpoint	SP2014N	
	250GB	7200	IDE, P-ATA	8MB	Spinpoint	SP2514N	
Western Digital	160GB	7200	IDE, P-ATA	8MB	WD Caviar SE	WD 1600JB	
	200GB	7200	IDE, P-ATA	8MB	WD Caviar SE	WD 2000JB	
	250GB	7200	IDE, P-ATA	8MB	WD Caviar SE	WD 2500JB	
	300GB	7200	IDE, P-ATA	8MB	WD Caviar SE	WD 3000JB	
Seagate	160GB	7200	IDE, P-ATA	8MB	Barracuda 7200.7	ST3160023A	
	160GB	7200	IDE, P-ATA	8MB	Barracuda 7200.9	ST3160812A	
	200GB	7200	IDE, P-ATA	8MB	Barracuda 7200.7	ST3200822A	
	250GB	7200	IDE, P-ATA	8MB	Barracuda 7200.8	ST3250823A	
	300GB	7200	IDE, P-ATA	8MB	Barracuda 7200.8	ST3300831A	
Maxtor	400GB	7200	IDE, P-ATA	8MB	Barracuda 7200.8	ST3400832A	
	160GB	7200	IDE, P-ATA	8MB	DiamondMax 10	6L160PO	[CAUTION] Check the HDD firmware version. (Code) : xxxx1Gxx1
	200GB	7200	IDE, P-ATA	8MB	DiamondMax 10	6L200PO	
	200GB	7200	IDE, P-ATA	8MB	DiamondMax 9	6Y200PO	
	200GB	7200	IDE, P-ATA	8MB	DiamondMax 10	6L200RO	
	200GB	7200	IDE, P-ATA	8MB	DiamondMax 10	6B200PO	
250GB	7200	IDE, P-ATA	16MB	DiamondMax 10	6L250RO		

• External CD-RW & DVD-RW

Maker	Model Name	Interface	Remark
Sony	DVD±RW DRX-810UL	USB2.0/IEEE1394	
LG	DVD-Multi GSA-2164D	USB2.0	
Plextor	PX-716UF DVD±RW	USB2.0/IEEE1394	
	Premium-U	USB2.0	
Sarotech	FCD-524	USB2.0/IEEE1394	

* DVD -R,-RW,+RW do not support.

• External HDD Case

Maker	Model Name	Interface	Remark
Sarotech	FHD 353	USB2.0/IEEE1394	http://www.sarotech.com/
DVico	FX-2	USB2.0/IEEE1394	http://www.dvico.co.kr/
Makeytec	MHD-998	USB2.0/IEEE1394	http://www.makeytec.com/

• USB Memory

Maker	Model	Remark
P & C	FDISK V2	
Stormblue	MICRO X	
ALTech	AnyDrive	
Bayon	Extreme USB Flash disk	
SanDisk	cruzer mini	
PNY	Attache	
GeekSquad		
Lexar	Jump Drive	
LG	Xtick Slide	
Sony	Ultra Mini USM	
Transcend	JF110	
Kingston	DTI	

* The USB Memory that is recognized as CD-Rom and Mass Storage(device type) on the PC is not supported.

3 Outline Drawing

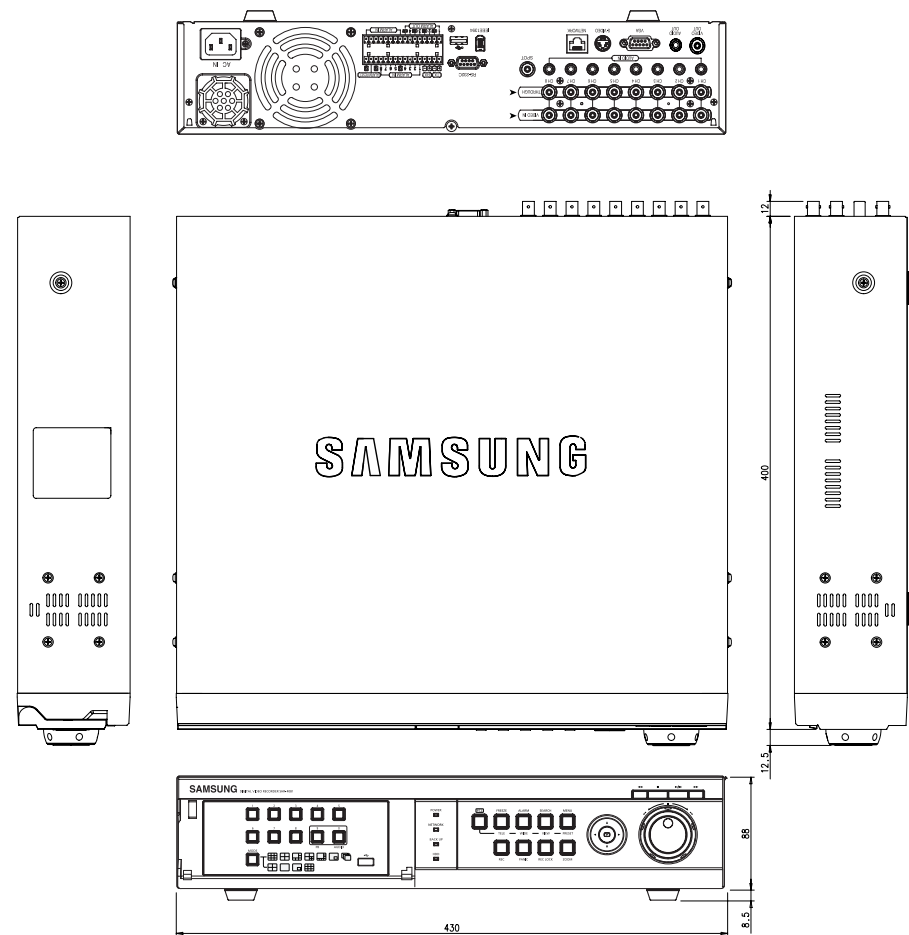

4 Factory Default

This restores the Network information and preset values in SHR-4081N/P to the original state at the time of factory shipment.

Factory Default will be done if you;

- Use System / Load Factory Default in MENU or,
- If you hold on to the Mode button in Live Mode and keep pressing the CH5 button for 5 seconds, the system will return to the Factory default condition.

Classification	Detailed Items		Factory Setup
System Setup	Time/Date/Language	Date Format	YYYY-MM-DD
		Time Format	24 Hours
		Language	English
		DST	Off
	Password	Password	4321
		Password Lock	On
HDD Mode Setup	Disk End Mode	Stop	
	Disk End Beep	Off	
Camera Setup	Camera Config	Video	On
		Audio	On
		Title	CAM_01 ~ CAM_8
		Auto Seq.	5 sec
	PTZ Device	ID	Camera No.
		Protocol	None
		Baudrate	9600
		Parity	None
		Data	8
		Stop	1
	Screen Setup	Serial Mode	Half Duplex
		Brightness	50
		Contrast	50
	Color	50	

5 SHR-4081N/P Smart Viewer Play Frame Specification

Classification	Detailed Items		Factory Setup
Monitoring Setup	Event Monitoring	Duration	Off
	OSG Display	Date	On
		Time	On
		Title	On
		Status	On
	Spot Out Channel		CH1
	Spot Out Event Monitor		Off
	Monitor Out		Composite Out
PB Channel Position		Right Down	
Multi Channel Seq.		5 Sec	
Record Mode Setup	Mode		On
	Video Size		CIF
	Quality		Very High
	Rate		15ips(NTSC)/12.5ips(PAL)
Record Schedule Setup	Continuous Recording		Off
	Event Recording		On
Event Record Setup	Event Record Mode	Video Size	CIF
		Quality	Very High
		Rate	15ips(NTSC)/12.5ips(PAL)
		PreEvent	10 sec
		PostEvent	1 min
	Alarm	Sensor State	Off
		Camera	Camera No.
		Alarm-Out	None
		A.O Dwell Time	10 sec
	Motion Detection	M.D State	Off
		Area	All Area
		Sensitivity	Medium
		Alarm-Out	None
		A.O Dwell Time	10 sec
	Video Loss	Video Loss State	Off
Alarm-Out		None	
A.O Dwell Time		10 sec	

NTSC

FRAME RATE	Viewer Screen Split Mode	VIDEO SIZE	
15		Half D1(N)	CIF (C)
	Nine-split	1 frame/sec	15 frame/sec
	Quad	15 frame/sec	15 frame/sec
	Single	15 frame/sec	15 frame/sec
10		Half D1(N)	CIF (C)
	Nine-split	10 frame/sec	10 frame/sec
	Quad	10 frame/sec	10 frame/sec
	Single	10 frame/sec	10 frame/sec
7.5		Half D1(N)	CIF (C)
	Nine-split	7.5 frame/sec	7.5 frame/sec
	Quad	7.5 frame/sec	7.5 frame/sec
	Single	7.5 frame/sec	7.5 frame/sec
5		Half D1(N)	CIF (C)
	Nine-split	5 frame/sec	5 frame/sec
	Quad	5 frame/sec	5 frame/sec
	Single	5 frame/sec	5 frame/sec
3		Half D1(N)	CIF (C)
	Nine-split	3 frame/sec	3 frame/sec
	Quad	3 frame/sec	3 frame/sec
	Single	3 frame/sec	3 frame/sec
1		Half D1(N)	CIF (C)
	Nine-split	1 frame/sec	1 frame/sec
	Quad	1 frame/sec	1 frame/sec
	Single	1 frame/sec	1 frame/sec

Note

The play frame specification of Smart Viewer varies on the setup of SHR-4081N/P Recording Rate and Video Size or the screen split mode of Smart Viewer. The above specification is applicable only when the main body of SHR-4081N/P is connected with a fast network like LAN. When the main body of SHR-4081N/P is connected with a slow network like ADSL, the play speed will be 0.5 Frame/sec. In addition, the above specification has been defined to the recommended specification of your PC. If your PC specification is lower than the recommended, the number of frame to played may diminish.

6 Troubleshooting(FAQ)

PAL

FRAME RATE	Viewer Screen Split Mode	VIDEO SIZE	
12.5		Half D1(N)	CIF (C)
	Nine-split	1 frame/sec	15 frame/sec
	Quad	15 frame/sec	15 frame/sec
	Single	15 frame/sec	15 frame/sec
8.33		Half D1(N)	CIF (C)
	Nine-split	10 frame/sec	10 frame/sec
	Quad	10 frame/sec	10 frame/sec
	Single	10 frame/sec	10 frame/sec
6.25		Half D1(N)	CIF (C)
	Nine-split	7.5 frame/sec	7.5 frame/sec
	Quad	7.5 frame/sec	7.5 frame/sec
	Single	7.5 frame/sec	7.5 frame/sec
5		Half D1(N)	CIF (C)
	Nine-split	5 frame/sec	5 frame/sec
	Quad	5 frame/sec	5 frame/sec
	Single	5 frame/sec	5 frame/sec
2.5		Half D1(N)	CIF (C)
	Nine-split	3 frame/sec	3 frame/sec
	Quad	3 frame/sec	3 frame/sec
	Single	3 frame/sec	3 frame/sec
1		Half D1(N)	CIF (C)
	Nine-split	1 frame/sec	1 frame/sec
	Quad	1 frame/sec	1 frame/sec
	Single	1 frame/sec	1 frame/sec

- The system power is dead and LED in front of the system does not operate at all.
 - Please check the power connection.
 - Check the power voltage.
 - If all your efforts like above end up with nothing, check or exchange the power supply.
- Video data remains in the system but some channels displays no video data but turns all blue.
 - Check the image of the camera connected to the system. Improper input of camera input may cause this symptom.
 - Check the camera power supply.
 - Sometimes, you see this symptom when the video data is connected with multi-systems and the video signal from the video data distributor in use feels weak. If it's the case, you shall connect the camera images with SHR-4081N/P DVR directly to check or improve such a symptom.
- The REC button in front has no effect on turning on REC LED or recording process.
 - Please check the HDD space.
 - Please check the Record Mode setup in MENU. It should be On.
- All the front LEDs are in operation but the monitor remains black.
 - Video out may come out differently with the connected monitor. In short, Video Out is set to Composite Output but connected to VGA Input Monitor or vice versa. Press the "MODE" button and "0" button of front left at the same time for 5 seconds, and press them to the time that the LED is On in sequence to change the Video Out mode.
- The front LED blinks and the logo screen repeatedly appears.
 - This symptom may be resulted from failure of HDD connection inside SHR-4081N/P DVR. Take off the cover and check HDD connection status. If HDD connection has no problem, please consult with the shop where you bought SHR-4081N/P DVR.
- You cannot enter MENU by forgotten password.
 - If you forget the password, you shall reset SHR-4081N/P DVR to the values set at the factory. Keep pressing both the "MODE" button and the "5" button on the left for 5 seconds until LED lights on in the order of 1→2→3→4→5. The password default is "4321".

7. The channel button does not operate in Live.
 - If the current screen is Event Monitoring, the channel button does not operate. Then, press the Alarm button to terminate the current screen and select a channel.
8. The cursor cannot reach Start during Calendar Search.
 - Please check both the channel and the date for play are left checked. Both shall be checked for play with Start. The cursor cannot reach the unrecorded date.
9. Alarm, once issued, keeps being issued though you press the front Alarm button for cancellation.
 - Press the front Menu button to cancel Alarm as follows.
 - 1) To cancel Event Monitoring Screen : Monitoring - Event Monitoring Duration Off
 - 2) To cancel Buzzer : Event Record - Alarm (Motion Detection/Video Loss) - Alarm-Out.
 - 3) To cancel Event : Event Record - Alarm (Motion Detection/Video Loss) - State Off.
10. No Response from the Live screen by pushing the PTZ button.
 - Press Menu → Camera → PTZ Device to check if the protocol and other items were set to PTZ Camera.
11. When you connect several IEEE1394 armored HDDs to SHR-4081N/P DVR through Menu, SHR-4081N/P DVR cannot recognize all the HDDs.
 - It requires time to recognize several armored HDDs. Please try again in a few minutes. If retrieval makes no improvement, HDD could be abnormal. Please exchange the HDD.
12. "CLOCK BATTERY HAS FAILED" appears on the screen.

It appears when there is an error in the time settings of the DVR built-in clock or any problem related to the built-in clock happens.

In addition, it prohibits the DVR operation to prevent loss of the data saved in the HDD.

Please contact the product A/S department and the vendor for examination.
13. You cannot connect to SHR-4081N/P DVR through Smart View.
 - Check if 3 Smart Viewer users are in connection with SHR-4081N/P DVR. SHR-4081N/P DVR allows no more than 3 users' connection with Smart Viewer at a time.
 - Check the Network setup of SHR-4081N/P DVR.
 - Check Network cable connection.

- When you use DHCP/ADSL(PPPoE) for connection, please check if you get the right SHR-4081N/P DVR MAC Address.
- If SHR-4081N/P DVR is connected to the ADSL network, please check if Bandwidth is set below 600 Kbps. If the Bandwidth for ADSL is set to high, the connection with Smart Viewer may be instable due to the heavy network load as the ADSL speed is low.

14. Smart Viewer in operation is disconnected.
 - If you change time, network setup, HDD format, Default Setup, or HDD attachment or detachment for SHR-4081N/P DVR, the current Smart Viewer will be automatically disconnected.
 - Check network connection. Smart Viewer, if disconnected from Network, will try reconnection up to 5 times. If it remains unconnected after 5 time trial, it will automatically give up connection.
 - As far as SHR-4081N/P DVR is connected to the ADSL network, you may be disconnected from Smart Viewer when the network conditions goes bad.
15. The Audio icon of Smart Viewer is left inactivated in the Live mode. Setting Audio to On in the Camera menu of SHR-4081N/P DVR will make no difference.
 - If your PC has no Audio driver or has some problem with Audio play of an Audio driver, the Audio icon will be inactivated. Please check Audio driver installation status.
16. When I select the channel which PTZ device is connected to in the Live mode of Smart Viewer, click the "Menu Control" button among PTZ setup buttons to enter the Function Menu mode in PTZ device, and return from the other channel, the PTZ related buttons have been initialized.
 - PTZ control is available in both Smart Viewer and SHR-4081N/P DVR. Other user might control PTZ for SHR-4081N/P DVR to terminate the PTZ device Menu or Auto Pan/Scan/Pattern motions while you select the other channel. This may cause the initialization.
17. No Time Bar in the Search
 - Time Line can be converted into 2 modes, General(24 Hour Display) and Extension(2 Hour Display). In the Extension mode, Time Bar may not be seen in the current time. Please enter the General mode or click the LEFT or RIGHT button to search Time Bar.



**Correct Disposal of This Product
(Waste Electrical & Electronic Equipment)**



(Applicable in the European Union and other European countries with separate collection systems)

This marking shown on the product or its literature, indicates that it should not be disposed with other household wastes at the end of its working life. To prevent possible harm to the environment or human health from uncontrolled waste disposal, please separate this from other types of wastes and recycle it responsibly to promote the sustainable reuse of material resources.

Household users should contact either the retailer where they purchased this product, or their local government office, for details of where and how they can take this item for environmentally safe recycling.

Business users should contact their supplier and check the terms and conditions of the purchase contract. This product should not be mixed with other commercial wastes for disposal.